



Innovation, Sciences et
Développement économique Canada
Office de la propriété intellectuelle du Canada

Innovation, Science and
Economic Development Canada
Canadian Intellectual Property Office



2020

Trademarks Journal

2020-01-15 — Vol. 67 No. 3403

Trademarks Journal

Vol. 67 No. 3403

General Information

The *Trademarks Journal* (the “*Journal*”) is published on the website of the Canadian Intellectual Property Office (<http://cipo.gc.ca>). The *Journal* lists trademark applications advertised under subsection 37(1) of the *Trademarks Act* (the “*Act*”), public notices of prohibited marks under section 9 of the *Act*, statements of the Minister in respect of geographical indications under subsection 11.12(2) of the *Act*, as well as erratums to previous volumes.

Electronic *Trademarks Journal*

The *Journal* is available in PDF format and can be downloaded free of charge and viewed and printed with Adobe Acrobat Reader. The *Journal* is also available in a printable HTML format as an alternate official version that contains a search function to narrow and customize the content. The electronic form of the *Journal* is the official version.

Official Languages

The *Journal* is available in English and French. The details displayed for each application are based on the language of the application. If the language of the application is English, the goods, services, or other text and description appearing in the English version of the *Journal* are in the language filed by the applicant. If the language of the application is French, the goods, services, or other text and description appearing in the English version of the *Journal* have been translated. Any registration resulting from the application will be restricted to these goods or services as described in the language of the application.

Filing Dates

The filing date of each trademark application (including those to extend the statement of goods or services of an existing registration) is shown in the YYYY-MM-DD format.

Nice Classification

Where applicable and required, the *Journal* lists the goods or services of each application grouped according to the classes of the Nice Classification, each group being preceded by the number of the class of the Nice Classification to which that group of goods or services belongs and presented in the order of the classes of the Nice Classification.

Opposition

Any person who has a valid ground of opposition (see section 38 of the *Act* for the grounds of opposition) to any application for registration of a trademark or to any application for registration of a trademark extending the statement of goods or services advertised in this *Journal* may file a statement of opposition with the Registrar of Trademarks within two months from the date of issue of this publication. The prescribed fee must accompany the statement of opposition.

ISSN 0041-0438 (printed)

ISSN 1701-4751 (online)

Table of contents

Advertised applications	5
Applications to extend the statement of goods or services	265
Public notices under section 9 of the <i>Trademarks Act</i>	272
Erratum	280

Advertised applications

Application Number 1,707,641
Language of Application English

Filing Date 2014-12-17

APPLICANT AND AGENT DETAILS**Applicant**

Werner URBAN
Großgeschwenda 51, 07330 Probstzella
GERMANY

Agent

MCCARTHY TETRAULT LLP
SUITE 2500, 1000 DE LA GAUCHETIERE
STREET WEST, MONTREAL, QUEBEC,
H3B0A2

TRADEMARK DETAILS**Trademark Type**

Design

Visual Representation**Goods****Class 01**

(1) chemicals contained in engine additives namely, oils, engine cleaners, oil performance enhancers, lubricants and greases for vehicle and industrial machinery, greases used for the care and maintenance of motor vehicles and motorcycles, industrial machinery and their parts, fuel systems, cooling systems, airconditioning systems and closed liquid circuits for vehicle and industrial machinery, other than foundry sand and products in the field of foundry materials and metallurgy; chemical agents for purifying industrial oils used for the maintenance and care of motor vehicles, industrial machinery and parts therefore, other than foundry sand and products in the field of foundry materials and metallurgy

Class 03

(2) bleaching preparations for the maintenance and care of motor vehicles, industrial machines and parts therefor; all purpose cleaning preparations for the maintenance and care of motor vehicles, industrial machines and parts therefor; polishes for the maintenance and care of motor vehicles, industrial machines and parts therefor; scouring preparations for the maintenance and

care of motor vehicles, industrial machines and parts therefor; general use abrasives for the maintenance and care of motor vehicles, industrial machines and parts therefor; industrial soaps for the maintenance and care of motor vehicles, industrial machines and parts therefor

Class 04

(3) dust absorbing namely, granular absorbent oil-based composition for absorbing spills from floors; wetting and binding composition for use in chemical additives for engine oils, engine cleaners, oil performance enhancers, lubricants, industrial greases, fuel injection systems for engines, engine cooling systems, and airconditioning systems for motor vehicles, motorcycles, and industrial machinery and their parts; industrial oils and greases; lubricants namely, all-purpose lubricants, automotive lubricants and industrial lubricants; fuels namely, motor spirit fuel, ethanol fuel, gasoline, diesel fuel and motor fuel

Claims

Priority Filing Date: June 17, 2014, Country or Office: EUIPO (EU), Application No: 013004494 in association with the same kind of goods (1)

Application Number 1,708,573
Language of Application English

Filing Date 2014-12-22

APPLICANT AND AGENT DETAILS

Applicant

Bondi Sands Pty Ltd
Unit 203E 126 Rouse Street Port
Melbourne 3207
AUSTRALIA

Agent

JOHN S. MCKEOWN
(Goldman Sloan Nash & Haber LLP), 480
University Avenue, Suite 1600 , Toronto,
ONTARIO, M5G1V2

TRADEMARK DETAILS

BONDI SANDS

Trademark Type

Word

Goods

Class 03

Cosmetics namely body creams; colour cosmetics for the skin; cosmetics; cosmetics for bronzing the skin; cosmetics for personal use; cosmetics for skin tanning; cosmetics for sun-tanning; cosmetics for use on the skin; cosmetics in the form of creams; cosmetics in the form of gels; cosmetics in the form of lotions; cosmetics preparations; non-medicated cosmetics; cosmetics namely oils for the skin; skincare cosmetics; cosmetics namely sprays for use on the body; cosmetics namely suntan lotion; cosmetics namely suntan milk; cosmetics namely suntan oils; cosmetics namely suntan preparations; cosmetics namely sun-tanning preparations; cosmetics namely sun-tanning creams; cosmetics namely sun-tanning oils; cosmetic preparations adapted for sun-tanning; cosmetic preparations for skin tanning; cosmetic preparations for tanning the skin; cosmetic preparations for use in giving a sun-tan effect; cosmetics for skin tanning; creams for tanning the skin; cosmetics namely self-tanning creams; cosmetics namely self-tanning lotions; cosmetics namely self-tanning mists; cosmetics namely self-tanning preparations; cosmetics namely sun-tanning preparations; cosmetics namely suntan lotions; cosmetics namely tanning creams; cosmetics namely tanning oils; cosmetics namely self-tanning preparations; self-tanning removing preparations.

Application Number 1,749,043
Language of Application English

Filing Date 2015-10-05

APPLICANT AND AGENT DETAILS

Applicant

GPN Commercial, LLC
3500 Lacey Road, Suite 1200
Downers Grove, IL 60515
UNITED STATES OF AMERICA

Agent

OSLER, HOSKIN & HARCOURT LLP
SUITE 1900, 340 ALBERT STREET,
OTTAWA, ONTARIO, K1R7Y6

TRADEMARK DETAILS

THINKTHIN

Trademark Type

Word

Goods

Class 05

(1) Dietary food supplements for general health and well-being; cereal-based, nut-based and chocolate-based snack foods for diabetics; cereal-based, oatmeal-based and chocolate-based snack foods for medically restricted diets; food supplements for general health and well-being

Class 29

(2) Nut-based snack foods; nut-based fruit snack bars; cheese crisps; nut-based meal replacement bars; Nut-based snack foods; nut-based and fruit snack bars

Class 30

(3) Breakfast cereals; oatmeal; protein and fiber enhanced oatmeal; hot oatmeal mixes; ready-to-eat oatmeal to be used as a breakfast food and snack food

(4) Prepackaged prepared meals consisting primarily of grains, namely oats; ready-to-eat prepared meals comprised primarily of grains, namely oats

(5) Cereal-based, granola-based, and grain-based snack foods and bars; pretzels; popcorn; frozen yogurt; cereal-based and chocolate-based meal replacement bars; chocolate-covered cereal-based, protein-based snack foods; cereal-based, and nutrient-dense protein, or fiber snack bars; chocolate-covered protein-based snack foods; nutrient-dense protein or fiber snack bars

Class 32

(6) Smoothie mixes

Claims

Priority Filing Date: June 19, 2015, Country or Office: UNITED STATES OF AMERICA, Application No: 86/668,974 in association with the same kind of goods (3); June 25, 2015, Country or Office: UNITED STATES OF AMERICA, Application No: 86/674,690 in association with the same kind of goods (2); July 08, 2015, Country or Office: UNITED STATES OF AMERICA, Application No: 86/686,873 in association with the same kind of goods (5); July 08, 2015, Country or Office: UNITED STATES OF AMERICA, Application No: 86/686,891 in association with the same kind of goods (6); July 08, 2015, Country or Office: UNITED STATES OF AMERICA, Application No: 86/686,863 in association with the same kind of goods (4)

Application Number 1,761,595
Language of Application English

Filing Date 2015-12-18

APPLICANT AND AGENT DETAILS

Applicant

The Burt's Bees Products Company
1221 Broadway Street
Oakland, California 94612
UNITED STATES OF AMERICA

Agent

NORTON ROSE FULBRIGHT CANADA LLP/S.
E.N.C.R.L.,S.R.L.
1, Place Ville Marie, Suite 2500, Montreal,
QUEBEC, H3B1R1

TRADEMARK DETAILS

Trademark Type

Design

Visual Representation

The logo for Burt's Bees, featuring the words "BURT'S" and "BEES" in a bold, serif font, stacked vertically and enclosed within a double-line border.

Goods

Class 03

(1) Home dental care products for dogs and cats, namely, toothpaste

Class 21

(2) Home dental care products for dogs and cats, namely, toothbrushes

Claims

Priority Filing Date: December 16, 2015, Country or Office: UNITED STATES OF AMERICA,
Application No: 86/851,579 in association with the same kind of goods (1)

Application Number 1,761,864
Language of Application English

Filing Date 2016-01-04

APPLICANT AND AGENT DETAILS

Applicant

Pitney Bowes Inc. (Delaware Corporation)
3001 Summer Street
Stamford, CT 06926
UNITED STATES OF AMERICA

Agent

MOFFAT & CO.
P.O. Box 2088, Station D, Suite 715-11
Holland Avenue, Ottawa, ONTARIO, K1Y4S1

TRADEMARK DETAILS

CRAFTSMEN OF COMMERCE

Trademark Type

Standard Characters

Goods

Class 09

(1) Computer controlled mail processing equipment for processing mail pieces, namely, meters for weighing mail and calculating postage; meters for weighing and calculating postage, not for office use; postage stamp checking apparatus, namely scanners; sorters with envelope handling, inserting, folding and sorting capabilities; printers for computers and printer cables; printers for use with computers; computer printers and digital color printers; laser printers; computer software, namely, computer software for tracking packages and mail; computer software for collecting, organizing, interpreting and reporting postage meter usage data; computer software for document production and mailing operations; computer software for tracking, tracing, auditing, monitoring, archiving and storing mail and postage information; computer software for data cleansing, managing mailing lists, assigning and updating mail delivery destination information, inserting graphic designs in mail, imaging compression, document and statement dynamic viewing and customization capabilities; printer and printer software used to design, layout, print and edit text, design graphics on envelopes, correct address information, and feed and stack envelopes in a printer; software for capturing, managing, accessing, mapping and displaying demographics information; software for geodemographic market analysis and market research of customers and prospects using and integrating demographic data and mapping information; software for embedding, analyzing and manipulating geographic and demographic information in other computer programs; software and web-based interfaces in the nature of graphic user interface software for management of printing, printer management, and for high volume document management, document production workflow, proofing layout of printed materials and user manuals therefor; software for managing and reporting the status and history of document formatting, routing and output, and software for implementing same; software that validates and cleanses address information; address-matching software allowing users to manage multiple databases; software allowing users to check for quality of address information, integration of address information and management of address information; electrostatic copier machines and multifunction printing machines, namely, computer and facsimile printers; computer programs carried on storage media for processing of mail pieces; software allowing users to create new

computer applications; computer programs carried on storage media for selection of mailing lists via a computer network or mobile application; computer programs carried on magnetic data media for designing of mail pieces.

(2) Computer controlled mail processing equipment for processing mail pieces, namely, meters for weighing mail and calculating postage; meters for weighing and calculating postage, not for office use; document, mail and package scanners; sorters with envelope handling, inserting, folding and sorting capabilities; printers for computers and printer cables; printers for use with computers; computer printers and digital color printers; laser printers; computer software, namely, computer software for tracking packages and mail; computer software for collecting, organizing, interpreting and reporting postage meter usage data; computer software for document production and mailing operations; computer software for tracking, tracing, auditing, monitoring, archiving and storing mail and postage information; computer software for data cleansing, managing mailing lists, assigning and updating mail delivery destination information, inserting graphic designs in mail, imaging compression, document and statement dynamic viewing and customization capabilities; printer and printer software used to design, layout, print and edit text, design graphics on envelopes, correct address information, and feed and stack envelopes in a printer; software for capturing, managing, accessing, mapping and displaying demographics information; software for geodemographic market analysis and market research of customers and prospects using and integrating demographic data and mapping information; software for embedding, analyzing and manipulating geographic and demographic information in other computer programs; software and web-based interfaces in the nature of graphic user interface software for management of printing, printer management, and for high volume document management, document production workflow, proofing layout of printed materials and user manuals therefor; software for managing and reporting the status and history of document formatting, routing and output, and software for implementing same; software that validates and cleanses address information; address-matching software allowing users to manage multiple databases; software allowing users to check for quality of address information, integration of address information and management of address information; electrostatic copier machines and multifunction printing machines, namely, computer and facsimile printers; computer programs carried on storage media for processing of mail pieces; software allowing users to create new computer applications; computer programs carried on storage media for selection of mailing lists via a computer network or mobile application; computer programs carried on magnetic data media for designing of mail pieces.

Claims

Priority Filing Date: December 01, 2015, Country or Office: UNITED STATES OF AMERICA, Application No: 86/835,514 in association with the same kind of goods

Application Number 1,767,646
Language of Application English

Filing Date 2016-02-12

APPLICANT AND AGENT DETAILS

Applicant

NVIDIA Corporation
2701 San Tomas Expressway
Santa Clara, CA 95050
UNITED STATES OF AMERICA

Agent

FASKEN MARTINEAU DUMOULIN LLP
800 rue Square-Victoria, BUREAU 3700, C.P.
242, MONTREAL, QUEBEC, H4Z1E9

TRADEMARK DETAILS

NVIEW

Trademark Type

Word

Goods

Class 09

(1) Computer software for desktop management; computer desktop management software; computer desktop utility software for workspace optimization and productivity maximization; computer software for document and database management; computer software for managing data for workspace optimization and productivity maximization; computer operating software; computer software used to enhance the capabilities and features of other software and non-downloadable online software; computer software used to manage and edit other software and non-downloadable online software.

(2) Computer software for document and database management; computer software for managing data for workspace optimization and productivity maximization; computer operating software; computer software used to enhance the capabilities and features of other software and non-downloadable online software; computer software used to manage and edit other software and non-downloadable online software.

Services

Class 42

Design and development of computer desktop management software, computer desktop utility software, document management software, database management software, data management software, computer operating software, computer software used to enhance the capabilities and features of other software and non-downloadable online software, computer software used to manage and edit other software and non-downloadable online software; updating, maintenance, installation and rental of computer desktop management software, computer desktop utility software, document management software, database management software, data management software, computer operating software, computer software used to enhance the capabilities and features of other software and non-downloadable online software, computer software used to manage and edit other software and non-downloadable online software; technical support services, namely troubleshooting in the nature of diagnosing computer hardware and software problems, information, advisory and consultancy services relating to all the aforesaid.

Claims

Priority Filing Date: August 12, 2015, Country or Office: EUIPO (EU), Application No: 014463558
in association with the same kind of goods (1) and in association with the same kind of services

Application Number 1,776,467
Language of Application English

Filing Date 2016-04-08

APPLICANT AND AGENT DETAILS

Applicant

Cynthia Levi
4000 Washington Road
McMurray, PA 15317
UNITED STATES OF AMERICA

Agent

SMART & BIGGAR LLP
SUITE 900, 55 METCALFE STREET, P.O.
BOX 2999, STATION D, OTTAWA, ONTARIO,
K1P5Y6

TRADEMARK DETAILS

BEAUTYTRIP.GREEN

Trademark Type

Word

Goods

Class 03

hair-care products, namely, shampoos and conditioners; finishing and styling products for humans and/or animals, namely, hairstyling gel, hairstyling spray, hairstyling preparation, hairspray, hair glaze, hair mousse, hair oil, hair wax, hair relaxer, hair-waving preparation, and heat-protectant spray; skin-care products, namely, body and facial lotions and moisturizers, body and facial cleansers, shaving creams, body and facial washes, and soaps

Claims

Priority Filing Date: October 08, 2015, Country or Office: UNITED STATES OF AMERICA,
Application No: 86/781,572 in association with the same kind of goods

Application Number 1,776,468
Language of Application English

Filing Date 2016-04-08

APPLICANT AND AGENT DETAILS

Applicant

Cynthia Levi
4000 Washington Road
McMurray, PA 15317
UNITED STATES OF AMERICA

Agent

SMART & BIGGAR LLP
SUITE 900, 55 METCALFE STREET, P.O.
BOX 2999, STATION D, OTTAWA, ONTARIO,
K1P5Y6

TRADEMARK DETAILS

BEAUTYTRIP

Trademark Type

Word

Goods

Class 03

hair-care products, namely, shampoos and conditioners; finishing and styling products for humans and/or animals, namely, hairstyling gel, hairstyling spray, hairstyling preparation, hairspray, hair glaze, hair mousse, hair oil, hair wax, hair relaxer, hair-waving preparation, and heat-protectant spray; skin-care products, namely, body and facial lotions and moisturizers, body and facial cleansers, shaving creams, body and facial washes, and soaps

Claims

Priority Filing Date: October 08, 2015, Country or Office: UNITED STATES OF AMERICA,
Application No: 86/781,562 in association with the same kind of goods

Application Number 1,789,528
Language of Application English

Filing Date 2016-06-30

APPLICANT AND AGENT DETAILS

Applicant

Cohesion Medical Ltd.
Unit 1.12, The Hub
Pacific Quay, Pacific Drive
Glasgow
UNITED KINGDOM

Agent

BERESKIN & PARR LLP/S.E.N.C.R.L., S.R.L.
SCOTIA PLAZA, 40 KING STREET WEST,
40th FLOOR, TORONTO, ONTARIO, M5H3Y2

TRADEMARK DETAILS

COHESION

Trademark Type

Standard Characters

Goods

Class 09

Computer software for controlling and managing personal, patient, care, clinical, medical and healthcare information namely patient contact and address data, patient personal identifying data, patient medical history data, patient medication and allergy data, medical diagnosis and treatment records, self-assessed patient medical status and symptoms data, patient genetic and family medical history data; application software for mobile phones, laptops, handheld computers, desktop computers, computer servers and for internet of things (IoT) enabled devices namely, software for use in personal, patient, care, clinical, medical and healthcare database management and the electronic storage of personal, patient, care, clinical, medical and healthcare data namely patient contact and address data, patient personal identifying data, patient medical history data, patient medication and allergy data, medical diagnosis and treatment records, self-assessed patient medical status and symptoms data, patient genetic and family medical history data; computer software and application software for clinical, medical and healthcare data recording, collection, reporting, integration, organisation, compilation, amalgamation; computer software and application software for compiling, storing, and managing personal, patient, care, clinical, medical and healthcare data namely patient contact and address data, patient personal identifying data, patient medical history data, patient medication and allergy data, medical diagnosis and treatment records, self-assessed patient medical status and symptoms data, patient genetic and family medical history data; computer software and application software for creating searchable databases of medical conditions and treatments information and data; electronic databases in the field of personal, patient, care, clinical, medical and healthcare data namely patient contact and address data, patient personal identifying data, patient medical history data, patient medication and allergy data, medical diagnosis and treatment records, self-assessed patient medical status and symptoms data, patient genetic and family medical history data; computer database systems of integrated applications for management of personal, patient, care, clinical, medical and healthcare data; computer software and application software for creating, organising, searching and updating databases of personal, patient, care, clinical, medical and healthcare data, information and records; biometric sensors for the collection of data

Services

Class 41

(1) Education and training in the fields of patient care and medicine; organization and conducting of workshops, seminars, working groups, research groups, events, symposia and conventions, in the fields of patient care and medicine; education and training in the fields of recording, collection, reporting, integration, organisation, compilation and amalgamation of clinical, medical and healthcare data; education and training in the fields of personal, patient, care, clinical, medical and healthcare data namely education and training in the field of recording and managing patient clinical data to measure and evaluate patient treatment-outcomes and in the field of analyzing clinical, medical and healthcare data; education and training in the fields of diagnosis and treatment of medical conditions

Class 42

(2) Computerised data storage; database design and development services; design and development of data models and of data entry, testing, measuring, monitoring and analysis systems and methods; integration of computer databases and systems; design and development of electronic data security systems; providing quality assurance in the medical and healthcare industries; IT (information technology) services, namely providing technical support, assistance and consultancy in the fields of medicine and healthcare namely technical support services in the form of provision of customer assistance services relating to use of computer hardware and software; IT (information technology) services, namely providing technical support, assistance and consultancy in the field of computer software and application soft-ware for data recording, collection, processing, reporting, analysis, integration, organisation, compilation, amalgamation, evaluation and management; IT (information technology) services, namely providing technical support, assistance and consultancy for computer software and application software in the field of personal, patient, care, clinical, medical and healthcare data and to the diagnosis and treatment of medical conditions; software consultancy and support services; design, development and programming of computer software for recording, collection, processing, reporting, analysis, integration, organisation, compilation, amalgamation, evaluation and management of data; design, development and programming of software in the field of clinical, medical and healthcare data; installation, maintenance, repair, integration, configuration, updating, programming and implementation of computer software for recording, collection, processing, reporting, analysis, integration, organisation, compilation, amalgamation, evaluation and management of data; installation, maintenance, repair, integration, configuration, updating, programming and implementation of computer software in the field of personal, patient, care, clinical, medical and healthcare data; medical and pharmacological research and development services; provision of information in the field of medical and pharmacological research and development

Class 44

(3) Information, advisory and consultancy services in the field of medicine, healthcare and community healthcare namely in the field of recording and managing patient clinical data to measure and evaluate patient treatment-outcomes and in the field of recording and managing patient contact and address data, patient personal identifying data, patient medical history data, patient medication and allergy data, medical diagnosis and treatment data, self-assessed patient medical status and symptoms data, patient genetic and family medical history data; medical and surgical diagnosis and treatment services; medical analysis and reporting services in the field of the treatment of patients; health assessment services; managed health care services, namely coordination and integration of healthcare and community healthcare services offered through a network of health care specialities, agencies and providers; preparation of reports in the field of

medicine and healthcare namely patient personal health reports comprising patient medical history data, patient medication and allergy data, patient medical diagnosis and treatment data, patient genetic and blood test data and patient family medical history data; medical testing services in the field of the diagnosis and treatment of diseases and conditions; providing information in the field of the management, preparation and dispensing of medications; medical diagnostic services; managed health care services namely, electronic processing of health care information; dental consultations and clinics; veterinary services; pharmacy services; computerised recording, collection, processing, reporting, analysis, integration, organisation, compilation, amalgamation, evaluation and management of data in the field of medicine and healthcare namely patient contact and address data, patient personal identifying data, patient medical history data, patient medication and allergy data, patient medical diagnosis and treatment data, patient genetic and blood test data and patient family medical history data

Claims

Priority Filing Date: January 18, 2016, Country or Office: EUIPO (EU), Application No: 015011216 in association with the same kind of goods and in association with the same kind of services

Application Number 1,790,299
Language of Application English

Filing Date 2016-07-04

APPLICANT AND AGENT DETAILS

Applicant

Sienna Biopharmaceuticals, Inc.
30699 Russell Ranch Road
Suite 140
Westlake Village, California 91362
UNITED STATES OF AMERICA

Agent

FINLAYSON & SINGLEHURST
225 Metcalfe Street, Suite 700, Ottawa,
ONTARIO, K2P1P9

TRADEMARK DETAILS

SIENNA BIOPHARMACEUTICALS

Trademark Type

Word

Goods

Class 05

- (1) Acne treatment preparations.
- (2) Pharmaceutical preparations for hair removal and reducing undesired hair growth.
- (3) Pharmaceutical preparations for use in dermatology, namely psoriasis, pruritus, itch, dermatitis, eczema, inflammation, skin redness, dermatologic oncology, skin discoloration, skin texture restoration, and skin hypersensitivity; pharmaceutical preparations for treatment of autoimmune skin diseases, namely pharmaceutical preparations for treatment of skin irritations, namely acne.

Claims

Priority Filing Date: January 08, 2016, Country or Office: UNITED STATES OF AMERICA, Application No: 86/870,214 in association with the same kind of goods (1); January 08, 2016, Country or Office: UNITED STATES OF AMERICA, Application No: 86/870,220 in association with the same kind of goods (3); January 08, 2016, Country or Office: UNITED STATES OF AMERICA, Application No: 86/870,217 in association with the same kind of goods (2)

Application Number 1,796,843
Language of Application English

Filing Date 2016-08-22

APPLICANT DETAILS

Applicant

Infogenetica Solutions Ltd.
Sunwood Square PO
P.O.Box 64743
Coquitlam
BRITISH COLUMBIA V3B 0H1

TRADEMARK DETAILS

NeuroActiv

Trademark Type

Word

Goods

Class 05

Natural oil dietary supplements containing Full Spectrum Fatty Acids for the promotion of better health.

Application Number 1,800,438
Language of Application English

Filing Date 2016-09-15

APPLICANT AND AGENT DETAILS

Applicant

TAMA PLASTIC INDUSTRY
Mishmar Ha'emek
ISRAEL

Agent

FASKEN MARTINEAU DUMOULIN LLP
800 rue Square-Victoria, BUREAU 3700, C.P.
242, MONTREAL, QUEBEC, H4Z1E9

TRADEMARK DETAILS

Trademark Type

Design

Visual Representation



Goods

Class 16

(1) Plastic materials for packaging and wrapping, namely plastic films, plastic sheeting for wrapping bales of cotton.

Class 17

(2) Plastic film for commercial use, namely commercial packing use and agricultural use and plastic sheeting for wrapping bales of crops; plastic materials in sheet form for wrapping agricultural crops.

Class 22

(3) Rope, cordage, twine, netting, and commercial net used for wrapping material for agricultural crops, all made of non-metallic materials, namely plastic, paper, starch, nylon, textile and rubber materials; baling twines; binder twines; tying twines; sisal ropes; netting products, namely bale wrap netting, pallet netting, and shade netting; horticultural twines; turf net.

Claims

Priority Filing Date: March 31, 2016, Country or Office: ISRAEL, Application No: 284189 in association with the same kind of goods

Application Number 1,808,467
Language of Application French

Filing Date 2016-11-08

APPLICANT AND AGENT DETAILS

Applicant

Lesaffre et Compagnie
41, rue Etienne Marcel
75001 Paris
FRANCE

Agent

SMART & BIGGAR LLP
1000 RUE DE LA GAUCHETIERE OUEST,
BUREAU 3300, MONTREAL, QUÉBEC,
H3B4W5

TRADEMARK DETAILS

PROCEL

Trademark Type

Word

Goods

Class 01

(1) Peptones used as nutrients for industrial fermentation; peptones used as nutrients for fermentation culture media for industrial fermentation, for microbial culture media for scientific use, for use in research, for cell culture media in the field of biotechnology.

Class 30

(2) Yeasts and yeast extracts used as raw materials for the fermentation industry; yeasts and yeast extracts used as fermentation media, as microbial culture media or as culture media for use in the production of biotechnology products.

Application Number 1,808,877
Language of Application English

Filing Date 2016-11-10

APPLICANT AND AGENT DETAILS

Applicant

DEL FRESCO PRODUCE LTD.
1414 Seacliff Drive
Kingsville
ONTARIO N9Y 2M2

Agent

KERR & NADEAU
190 O'Connor Street, Suite 610, Ottawa,
ONTARIO, K2P2R3

TRADEMARK DETAILS

Go!Berries

Trademark Type

Word

Goods

Class 31

Fresh produce, namely fruits and vegetables; fresh fruits and vegetables

Application Number 1,812,297
Language of Application English

Filing Date 2016-12-02

APPLICANT AND AGENT DETAILS

Applicant

CARAPPELLI FIRENZE, S.P.A.
Via Leonardo Da Vinci, 31 Località
Sambuca 50028 Tavarnelle Val Di Pesa
Firenze
ITALY

Agent

BLANEY MCMURTRY LLP
Suite 1500, 2 Queen Street East, Toronto,
ONTARIO, M5C3G5

TRADEMARK DETAILS

Trademark Types

Design
Position

Visual Representation



Trademark Description

The trademark consists of the position of the colour green as applied to the whole visible surface of a three-dimensional bottle and the position of two labels applied to a three-dimensional bottle, as shown in the visual representation. The upper label contains, from top to bottom, the words "ORO VERDE", "EXTRA VIRGIN", "OLIVE OIL", "FIRST COLD PRESSED", "34 FL OZ (1L)", and a map of Italy located to the right of the words "34 FL OZ (1L)". The lower label contains, from top to bottom, the words "CASA", "OLEARIA", "CARAPPELLI", "FIRENZE", "1893" and an olive cluster design located to the top right of the word "CARAPPELLI". The three-dimensional bottle shown in dotted outline in the drawing does not form part of the trademark but is included merely to show the positioning of the sign.

Colour Claim

Colour is claimed as a feature of the trademark. The visible surface of the bottle is green. The upper label is light green with the words 'ORO VERDE EXTRA VIRGIN OLIVE OIL' written in black, the words 'FIRST COLD PRESSED' written in white, the phrase '34 FL OZ (1L)' in black and a map of Italy in white to the right of it. The lower label is light green with the words 'CASA

OLEARIA CARAPELLI FIRENZE 1893' written in black and the olive cluster design above the wording has green leaves, a beige branch, and purple olives.

Disclaimer

The right to the exclusive use of the words Extra virgin olive oil, First cold pressed and 34 FL OZ (1L) is disclaimed apart from the trademark.

Foreign Character Translation

The translation provided by the applicant of the word(s) 'ORO VERDE', 'CASA OLEARIA' and 'FIRENZE' is 'green gold', 'home of oil', 'oil mill' or 'oily', and 'Florence'.

Goods**Class 29**

Extra virgin olive oil.

Application Number 1,814,624
Language of Application English

Filing Date 2016-12-13

APPLICANT AND AGENT DETAILS

Applicant

AWIN LTD
2 Thomas More Square
London, E1W 1YN
UNITED KINGDOM

Agent

FOGLER, RUBINOFF LLP
77 KING STREET WEST, SUITE 3000, P.O.
Box 95, TORONTO-DOMINION CENTRE,
TORONTO, ONTARIO, M5K1G8

TRADEMARK DETAILS

AWIN

Trademark Type

Word

Goods

Class 09

Computer software for use in database management, use as a spreadsheet and word processing in the field of performance marketing, affiliate marketing and advertising services and computer hardware; electronic publications namely, newsletters, whitepapers, downloadable multimedia news weblogs containing blog posts and social media posts, downloadable multimedia news webcasts, downloadable multimedia news podcasts, downloadable digital video recordings, journals and books in the field of performance marketing, affiliate marketing and advertising services and downloadable electronic data files featuring data namely, newsletters, whitepapers, downloadable multimedia news weblogs containing blog posts and social media posts, downloadable multimedia news webcasts, downloadable multimedia news podcasts, downloadable digital video recordings in the field of movies, music videos, television programs, clips of movies and television programs, video messages and user uploaded video clips, journals and books for analyzing consumer behaviour and facilitating online advertising, all the foregoing downloaded and downloadable via the Internet and other remote communication devices, namely, smartphones and tablets; interactive entertainment software, namely computer games, video games, downloadable electronic games and interactive multimedia computer games; social networking software, namely software featuring user generated content in the field of electronic, video, and computer games, computer software for collaboration, namely, collaborative computer software that enables individuals to upload, download, retrieve, discuss and share digital documents, digital information, digital video, digital audio, text and digital images and pictures, all featuring user generated business and personal information and all being electronically recorded or downloadable from the Internet, extranets or other communications networks for the purpose of facilitating communications between co-workers and facilitating social networking, downloadable computer software and mobile applications for use in instant messaging and online chat, computer software in the field of social media to enable uploading, downloading, accessing, posting, displaying, blogging, linking, or sharing of userdefined and user-generated text, music, videos, audio, animation and images via computer, the Internet and radio, satellite and cellular communications networks; community software, namely computer software for use in database management, use as a spreadsheet and word processing in the field of performance marketing, affiliate marketing and advertising services for use within a virtual community; education software

featuring instruction in performance marketing, affiliate marketing and advertising services, the primary purpose of which is teaching and self-learning; marketing software for use in database management, use as a spreadsheet and word processing in the field of performance marketing, affiliate marketing, advertising on the Internet for others and marketing software with the purpose of marketing automation; computer software for advertising the goods and services of others by providing classified advertising space to third parties via global computer and wireless networks; computer software for marketing, namely, for developing and administering customer performance tracking, reward and incentive programs and with the use of marketing automation; computer software for market research; computer software for business security; computer software for business consultancy, namely for use in database management, use as spreadsheet and word processing for business consultancy in the field of performance marketing, affiliate marketing and online advertising; computer software for affiliate marketing, for analyzing consumer behaviour and facilitating online advertising; computer software for affiliate marketing network services for analyzing consumer behaviour and facilitating online advertising; none of the aforesaid relating to software for sales and inventory management by dealers in the motor industry.

Services

Class 35

(1) Advertising and promotion services, namely, providing classified advertising space to third parties via global computer and wireless networks; business consultancy in the field of marketing and advertising; compilation of information into databases; business research, namely, providing business marketing information for others; marketing analysis services, planning of marketing strategies; trade and promotional marketing, namely marketing research and marketing studies; computerized information storage, namely computerized database management; dissemination and retrieval of business information and data via the Internet, namely, performance marketing, affiliate marketing and online advertising; business information services in the field of performance marketing, affiliate marketing and online advertising; business services provided online from a computer database or the Internet, namely, providing computer database containing advertisements from third parties via global computer and wireless networks; compilation of advertisement for use as web pages on the Internet; business recommendation services, namely advisory services for business management; provision of business information in the field of performance marketing, affiliate marketing and online advertising; marketing services agency; business account management services; business data analysis, namely, market analysis and economic analysis; business data analysis for the provision of advice in relation to business security, namely business management services relating to information and data compiling and analyzing in the field of business security, business management consultancy and development of processes for the analysis and the implementation of strategy plans and management projects in the field of business security, business organization advice for others in the field of business security and business data analysis services, namely, internet security consultancy for businesses; provision of market research information services; business marketing consulting services; marketing forecasting services; marketing studies services; marketing analysis services; marketing research services; business consultancy services related to marketing; advertising agency services; affiliate marketing services, namely, facilitating partnerships between affiliates and merchants in connection with online advertising campaigns and e-commerce transactions, namely, dissemination of advertising for others via the Internet and promoting the goods and services of others through advertisements on Internet websites; affiliate marketing network services, namely, providing and operating a merchant affiliate network platform that allows enrolled digital content

publishers to provide offers, discounts and rewards relating to participating third party merchant's products and services to its users and that allows participating merchants to create customized offers, discounts and rewards specific to enrolled digital content publishers or their users.

Class 38

(2) Business/commercial management of communication networks, namely the operation and administration of telecommunication networks, namely radio, telephone, cable and satellite communication networks and global computer networks for others.

Class 42

(3) Software development, design, maintenance, software programming, engineering, research and writing; advisory and consultancy services relating to computer software and computer software development, design, maintenance, consultancy, programming, engineering, research and writing; computer software development, design, maintenance, consultancy, programming, engineering, research and writing; computer and video games development; development of computer software for advertising; development of computer software for marketing; development of computer software for market research; development of computer software for business security; development of computer software for business consultancy; development of computer software for affiliate marketing; development of computer software for affiliate marketing network services; creation of computer graphics; computer game design services; design and development services in the field of computer and video games and interactive products, namely computer games, video games, downloadable electronic games and interactive multimedia computer games; design services in the field of the production of computer and video games and interactive entertainment products, namely computer games, video games, downloadable electronic games and interactive multimedia computer games; social network software and virtual worlds software development; hosting online web facilities for others; creating, maintaining and hosting websites of others; computer services, namely, hosting online web facilities for others for organizing and conducting interactive meetings; computer services, namely, hosting online web facilities for others for organizing and conducting interactive discussions; design services, namely, the production of computer and video games for use in connection with performance marketing, affiliate marketing and advertising services.

Application Number 1,818,083
Language of Application English

Filing Date 2017-01-13

APPLICANT AND AGENT DETAILS

Applicant

Parsons Corporation
100 West Walnut Street
Pasadena, CA 91124
UNITED STATES OF AMERICA

Agent

CASSELS BROCK & BLACKWELL LLP
SCOTIA PLAZA, SUITE 2100, 40 KING
STREET WEST, TORONTO, ONTARIO,
M5H3C2

TRADEMARK DETAILS

Trademark Type

Design

Visual Representation



Colour Claim

Colour is claimed as a feature of the trade-mark. The mark consists of a plus sign where the right arm is red, the bottom arm is green, the left arm is blue, the top arm is yellow, and the central block is orange.

Goods

Class 09

Computer hardware and software system for remotely monitoring environmental conditions and controlling devices within a building, facility, grounds, or designated spatial area; environmental monitoring systems comprised of meters and sensors that measure pressure, humidity, temperature and includes alarm and reporting functions; computer software for civil, mechanical, environmental, computer, electrical, software, systems engineering design, project cost estimating, construction project management, facility operations, and building information modeling; computer aided design (CAD) software for construction; computer software for water management in the field of water quality monitoring and assessment, watershed-based storm water planning and design, storm water utility development and implementation, combined sewer overflow analysis, flood control, sedimentation, river engineering, FEMA flood insurance studies, hydraulic modeling and design, ecosystem restoration and geomorphic assessment, dam safety analysis, and ground water development and management; computer software for water management in the field of aquifer storage and recovery conjunctive management planning, water rights and water availability modeling, reservoir operations analysis, in-stream flow assessments, and wetlands mitigation banking; computer software for management of capital improvement programs, construction projects, asset and facilities management and related project documentation for capital

improvement and construction projects; computer software for use in energy assessment and capital planning; computer software for use in energy assessment planning for collection, recording and analysis of data regarding current energy conditions, adequacy, inventory and usage in a building for the purpose of justifying funding, developing energy-specific construction plans, executing construction projects, determining energy utilization and determining compliance with energy and environmental design standards

Services

Class 35

(1) Business consultation services in the field of facilities management in the field of transportation, energy efficiency, water management and reservoir operations; business management; business management services in the nature of facilities management in the field of transportation; consultation in the field of energy efficiency; energy usage management information services; business services, namely, business management relating to water management and reservoir operations analysis; providing an internet accessible database in the field of scheduling and cost data for civil, mechanical, environmental, computer, electrical, software, systems engineering design and building construction programs

Class 36

(2) Providing information via a global computer network on the subject of non-residential building and facilities management; and providing an Internet accessible data base in the field of financial information for civil, mechanical, environmental, computer, electrical, software, systems engineering design and building construction programs

Class 37

(3) Building construction services; building construction, rebuilding and remodeling namely to dismantle and rebuild and repair of non-residential buildings; construction project management and building inspection of facilities for environmental activities, transportation, process activities, power generation, oil and gas production, industrial activities, space exploration, defense, municipal services, recreation, oil and gas facilities, pipelines, pipeline terminals, electricity generation and transmission and distribution facilities, petrochemical facilities, manufacturing plants, biomass generation facilities, and alternative energy production facilities; consulting services for the construction of facilities for environmental activities, transportation, process activities, power generation, oil and gas production, industrial activities, space exploration, defense, municipal services, recreation, oil and gas facilities, pipelines, pipeline terminals, electricity generation and transmission and distribution facilities, petrochemical facilities, manufacturing plants, biomass generation facilities, and alternative energy production facilities, and construction consultation services, namely planning, and supervision, building construction information, providing an on-line interactive database in the field of building construction and repair and commercial building construction via the Internet, providing information via the Internet for managing construction and consulting projects in the field of construction, construction of airports, roads, manufacturing facilities, data centers, water facilities, electricity facilities, telecommunications facilities, energy generation and transmission facilities, chemical process plants, transportation infrastructure, dams, landfills, housing, educational facilities, hotels, theme parks, buildings, facilities for disposal of weapons, healthcare facilities, vehicle inspection and compliance facilities, military installations, oil and gas facilities, pipelines, pipeline terminals, electricity generation and transmission and distribution facilities, petrochemical facilities, manufacturing plants, biomass generation facilities, and alternative energy production facilities, providing information services relating to the construction, repair, and rebuilding of schools, retail stores, hotels, theme parks, dams, water systems, waste water treatment plants, water treatment

plants, environmental remediation facilities, pharmaceutical production facilities, biotech production facilities, chemical destruction facilities, sewer systems, environmental designs, transportation facilities, building construction management, construction planning and inspection, oil and gas facilities, pipelines, pipeline terminals, electricity generation and transmission and distribution facilities, petrochemical facilities, manufacturing plants, biomass generation facilities and alternative energy production facilities

Class 40

(4) Bioremediation services.

Class 42

(5) Civil, mechanical, environmental, aerospace, computer, electrical, software, systems engineering; consulting in the field of civil, mechanical, environmental, aerospace, computer, electrical, software, systems engineering and architecture; consulting in the field of architecture; design of engineering products; drafting of plans and engineering drawings, namely, blueprints, for others; design services in the fields of construction and renovation; computer security consultancy; design and development of electronic data security systems; development of security systems and contingency planning for information systems; testing of electronic data security systems; computer modeling services namely providing 3D modeling and simulation software services; computer technology support services namely, help desk services; computer services, namely, acting as an application service provider in the field of knowledge management to host computer application software for the purpose of contract documentation, team collaboration and communication, and reporting; computer aided design for others; graphic design; graphic illustration services; reviewing standards and practices to assure compliance with environmental and safety laws and regulations, namely, program evaluation and recommendations for others, administration of environmental vendor contracts for others, and implementation of compliance programs for others; integration of computer systems, software, and networks for others in the fields of construction and engineering; planning, civil, mechanical, environmental, aerospace, computer, electrical, software, systems engineering, project management, design, architecture, consulting, inspection, permit acquisition services, in the field of construction and renovation of private and public facilities; energy auditing; and updating of computer software relating to computer security and prevention of computer risks

Class 45

(6) Security services, namely, providing security assessments for physical locations, information systems, working environments for businesses and governmental agencies; security consultancy namely computer security consultation, internet security consultation; data security consultation; physical security consultation; permit acquisition, namely, obtaining environmental, design, zoning and other governmental permits for development projects for facilities for environmental activities, transportation, process activities, power generation, oil and gas production, industrial activities, space exploration, defense, municipal services, recreation, oil and gas facilities, pipelines, pipeline terminals, electricity generation and transmission and distribution facilities, petrochemical facilities, manufacturing plants, biomass generation facilities, and alternative energy production facilities

Application Number 1,818,456
Language of Application English

Filing Date 2017-01-17

APPLICANT AND AGENT DETAILS

Applicant

R-U-ONTRAK PTY LTD
SUITE 3 , 60 - 64 RAILWAY ROAD
BLACKBURN VIC 3130
AUSTRALIA

Agent

ACCUPRO TRADEMARK SERVICES LLP
SUITE 702 - 401 WEST GEORGIA STREET,
VANCOUVER, BRITISH COLUMBIA, V6B5A1

TRADEMARK DETAILS

Trademark Type

Design

Visual Representation

R-U-ONTRAK 

Goods

Class 09

Computer software in the medical and healthcare field the function of which is for managing, recording, tracking, sharing, collating, retrieving, processing, analysing, storing data and information in respect of individuals medical history which includes personal injury, medical recovery, rehabilitation, individuals general health, prevention of illness, disease and personal injury, fitness, sleep, mental health and wellness, nutrition adapted for medical practitioners and specialists, surgeons, physiotherapists, sports medicine, osteopaths, mental health, other allied health disciplines, and providers in the rehabilitation and recovery fields namely massage therapists, acupuncturists, sports science, sport, strength and conditioning and alternative medicines, all of the aforesaid to provide communication connections and communication software to users, medical and rehabilitation providers and others;

Claims

Priority Filing Date: July 21, 2016, Country or Office: AUSTRALIA, Application No: 1784931 in association with the same kind of goods

Application Number 1,821,600
Language of Application English

Filing Date 2017-02-06

APPLICANT AND AGENT DETAILS

Applicant

R-U-ONTRAK PTY LTD
SUITE 3, 60-64 RAILWAY ROAD
BLACKBURN VIC 3130
AUSTRALIA

Agent

ACCUPRO TRADEMARK SERVICES LLP
SUITE 702 - 401 WEST GEORGIA STREET,
VANCOUVER, BRITISH COLUMBIA, V6B5A1

TRADEMARK DETAILS

Trademark Type

Design

Visual Representation



Goods

Class 09

Computer software in the medical and healthcare field the function of which is for managing, recording, tracking, sharing, collating, retrieving, processing, analysing, storing data and information in respect of individuals medical history which includes personal injury, medical recovery, rehabilitation, individuals general health, prevention of illness, disease and personal injury, fitness, sleep, mental health and wellness, nutrition adapted for medical practitioners and specialists, surgeons, physiotherapists, sports medicine, osteopaths, mental health, other allied health disciplines, and providers in the rehabilitation and recovery fields namely massage therapists, acupuncturists, sports science, sport, strength and conditioning and alternative medicines, all of the aforesaid to provide communication connections and communication software to users, medical and rehabilitation providers and others;

Claims

Priority Filing Date: August 09, 2016, Country or Office: AUSTRALIA, Application No: 1788442 in association with the same kind of goods

Application Number 1,822,041
Language of Application English

Filing Date 2017-02-09

APPLICANT AND AGENT DETAILS

Applicant

New York Coffee W.L.L.
375 Brisdale Dr
Brampton
ONTARIO L7A 3K7

Agent

GOWLING WLG (CANADA) LLP
SUITE 2600, 160 ELGIN STREET, OTTAWA,
ONTARIO, K1P1C3

TRADEMARK DETAILS

Trademark Type

Design

Visual Representation



Disclaimer

The right to the exclusive use of the words 'New York' and 'Coffee' is disclaimed apart from the trademark.

Goods

Class 30

beverages made of coffee; caffeine-free coffee; coffee; coffee and coffee substitutes; coffee and tea; coffee based beverages; coffee beverages with milk; coffee essences; coffee essences for use as substitutes for coffee; coffee extracts; coffee extracts for use as substitutes for coffee; coffee substitutes; coffee-based beverages; granulated coffee for drinks; ground coffee beans; iced coffee; instant coffee; prepared coffee and coffee-based beverages; roasted coffee beans; roasted coffee for drinks; unroasted coffee

Services

Class 43

café services; cafe-restaurants; cafés; carry-out restaurants; coffee shops; coffee supply services; coffee supply services for offices; fast-food restaurants; reservation of restaurants; restaurants; self service restaurants; self-service restaurants

Application Number 1,822,274
Language of Application English

Filing Date 2017-02-10

APPLICANT AND AGENT DETAILS

Applicant

YANMAR CO., LTD.
1-32 CHAYAMACHI, KITA-KU
OSAKA 530-8311
JAPAN

Agent

MOFFAT & CO.
P.O. Box 2088, Station D, Suite 715-11
Holland Avenue, Ottawa, ONTARIO, K1Y4S1

TRADEMARK DETAILS

Trademark Type

Design

Visual Representation



ecoY

Goods

Class 07

(1) construction equipment, namely concrete drills, cement cutters, concrete construction machines, excavating machines, wheel loaders, power shovels, bulldozers, and backhoes and parts and fittings for concrete drills, cement cutters, concrete construction machines, excavating machines, wheel loaders, power shovels, bulldozers and backhoes; parts and fittings for excavators used in construction and agriculture, namely, rollers, sprockets, idlers, rubber tracks, steel tracks, crawler pads, tire chains, track links and bucket teeth, repair and replacement parts therefore

Class 12

(2) motorised all-terrain carriers, namely all-terrain vehicles, carriers for construction machinery, namely trailers and fittings for motorized all-terrain carriers, namely all-terrain vehicles, carriers for construction machinery, namely trailers; land vehicles for use in construction, namely tractors, excavators, trailer; land vehicles for use in agriculture, namely tractors, carts and wagons; tractors and automobiles, air bags [safety devices for automobiles], windscreens of automobiles, clutch pedals of automobiles, warning horns for automobiles, seats for automobiles, seat covers for automobiles, automobile bodies, wheels for automobiles, spokes for automobiles, automobile tires, inner tubes for automobile tires, doors for automobile, doors for automobiles, mudguards for automobiles, steering wheels for automobiles, rims for automobiles, chassis of automobiles,

luggage carriers of automobiles, structural parts and fittings; parts and fittings for tractors, trailers, carts and wagons used in construction and agriculture, namely, rollers, sprockets, idlers, rubber tracks, steel tracks, crawler pads, tire chains, track links and bucket teeth, repair and replacement parts therefore

Services

Class 37

rental of construction machines and apparatus; rental of excavators; rental of wheel loaders; rental of backhoes; vehicle maintenance and repair; installation, maintenance and repair of construction machines; installation, maintenance and repair of excavators; installation, maintenance and repair of wheel loaders; installation, maintenance and repair of backhoes

Application Number 1,833,380
Language of Application English

Filing Date 2017-04-19

APPLICANT AND AGENT DETAILS

Applicant

STUDEX CORPORATION, a legal entity
521 W. Rosecrans Avenue
Gardena, CA 90248
UNITED STATES OF AMERICA

Agent

RICHES, MCKENZIE & HERBERT LLP
SUITE 1800, 2 BLOOR STREET EAST,
TORONTO, ONTARIO, M4W3J5

TRADEMARK DETAILS

Trademark Type

Three-dimensional (3-D)

Visual Representation

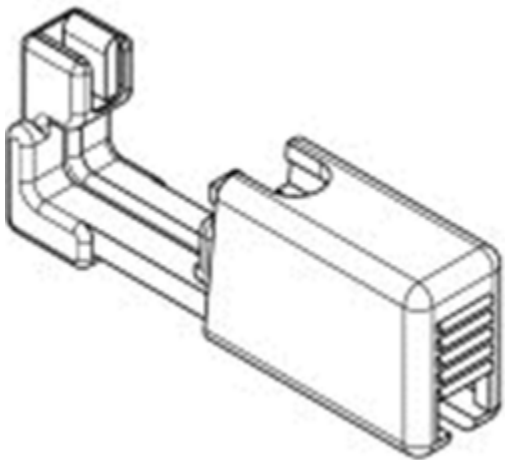

Trademark Description

The three-dimensional shape consists of a rectangular body on one end, and a curved backing on the other, both of which are connected by a grooved channel.

Territorial Restriction

Registration is restricted to the provinces of Alberta, British Columbia, Manitoba, New Brunswick, Newfoundland and Labrador, Ontario, Prince Edward Island, Quebec, and Saskatchewan.

Registrability Recognized

Registrability recognized under the Trademarks Act.

Goods

Class 08

Body piercing cartridge.

Application Number 1,836,636
Language of Application English

Filing Date 2017-05-10

APPLICANT AND AGENT DETAILS

Applicant

BODY PLUS NUTRITIONAL PRODUCTS
INC., a
legal entity
130 McLevin Avenue, Unit 5
Toronto
ONTARIO M1B 3R6

Agent

MAGYAR, BOGLE & O'HARA LLP
2842 Bloor Street West, Suite 101, Toronto,
ONTARIO, M8X1B1

TRADEMARK DETAILS

Trademark Type
Design

Visual Representation



Goods

Class 05

Natural health products, nutritional supplements and food products for enhanced athletic performance and general health and well-being, namely protein supplements and weight gain drink mixes in powder and bar form

Application Number 1,839,759
Language of Application English

Filing Date 2017-05-29

APPLICANT AND AGENT DETAILS

Applicant

Ms. ROWENA WENCK
UNIT 2/8 CHARM PLACE
PEAKHURST NSW, 2210
AUSTRALIA

Agent

ACCUPRO TRADEMARK SERVICES LLP
SUITE 702 - 401 WEST GEORGIA STREET,
VANCOUVER, BRITISH COLUMBIA, V6B5A1

TRADEMARK DETAILS

LITTLE BUBS

Trademark Type

Word

Goods

Class 21

Brushes, namely, brushes for personal use in the nature of cosmetic brushes, brushes for cleaning hair, skin, nails and teeth, brushes for personal hygiene namely make up and cosmetic brushes, skin cleansing brushes, bath brushes and babies' brushes namely brushes for use on skin for cleaning and the application of skin creams and skin care preparations; applicators namely brushes for use on skin; cases, containers, holders and dispensers with or without lids that have been specifically adapted for use with brushes for personal use in the nature of cosmetic brushes and make-up applicators and toilet paper holders for storage purposes; dispensing devices, namely, skin cream, skin lotion and make-up and cosmetic dispensers; household cases and containers for the storage of skin creams, cosmetics and other substances namely skin and hair care preparations; stands specifically adopted for use with brushes for personal use in the nature of cosmetic brushes, brushes for cleaning hair, skin, nails and teeth, brushes for personal hygiene namely make up and cosmetic brushes, brushes for cleaning hair, skin, nails and teeth, brushes for personal hygiene namely make up and cosmetic brushes, skin cleansing brushes, bath brushes and babies' brushes namely brushes for use on skin for cleaning and the application of skin creams and skin care preparations; skin cleansing brushes, bath brushes and babies' brushes namely brushes for use on skin for cleaning and the application of skin creams and skin care preparations; toilet paper dispensers; applicator brushes and brushes for the application of skin cream; cases, containers, holders and dispensers with or without lids that have been specifically adapted for use with brushes for personal use in the nature of cosmetic brushes, make up applicators in the nature of make-up applicator wands and brushes, toilet paper holders for household storage purposes; dispensing devices, cases and containers for skin creams, cosmetics and other substances namely skin and hair care preparations; stands sold empty to hold toiletries;

Application Number 1,842,089
Language of Application English

Filing Date 2017-06-12

APPLICANT AND AGENT DETAILS

Applicant

Godovychenko Sergiy
Arhitektora Nikolaeva vulutsya, 5, apt.
93
Kyiv 02225
UKRAINE

Agent

YURI CHUMAK
(c/o Chumak & Company LLP), 1201 Dundas
Street East , Suite 201, Toronto, ONTARIO,
M4M1S2

TRADEMARK DETAILS

Trademark Type

Design

Visual Representation



Colour Claim

Colour is claimed as a feature of the trademark. The word VIVO is white, the oval is blue.

Goods

Class 11

(1) Electric yogurt makers.

Class 30

(2) Leaven, namely, starter cultures and media for use in the production of yogurt and milk products.

Application Number 1,842,268
Language of Application English

Filing Date 2017-06-13

APPLICANT AND AGENT DETAILS

Applicant

PK Technologies Inc.
2112, 222 Riverfront Avenue SW
Calgary
ALBERTA T2P 0X2

Agent

RIDOUT & MAYBEE LLP
250 University Avenue, 5th Floor, Toronto,
ONTARIO, M5H3E5

TRADEMARK DETAILS

Trademark Type

Design

Visual Representation



Goods

Class 01

Hydrocarbon additives for heavy oil production.

Services

Class 40

Processing of heavy oil.

Application Number 1,845,731
Language of Application English

Filing Date 2017-07-04

APPLICANT AND AGENT DETAILS

Applicant

CESARI S.R.L.
Via Stanzano, 1120
40024 Castel S. Pietro Terme
Bologna
ITALY

Agent

MOFFAT & CO.
P.O. Box 2088, Station D, Suite 715-11
Holland Avenue, Ottawa, ONTARIO, K1Y4S1

TRADEMARK DETAILS

MASSERIA NOHA

Trademark Type

Word

Foreign Character Translation

As provided by the applicant, the words MASSERIA NOHA translate to NOAH'S FARM in English

Goods

Class 33

alcoholic beverages, namely, wines, sparkling wines, red wines, white wines, rose wines, sweet wines, wine based beverages, namely spritzers; Grappas

Services

Class 35

(1) providing home shopping services of wine and alcoholic beverages via the Internet; alcoholic beverage procurement services for others; providing marketing and consulting in the field of wine and alcoholic beverages, namely organization of contests, market surveys, tastings and samplings for the communication and promotion of alcoholic beverages for others; promotional services in the field of wines, wine based beverages and Grappas, namely organization of tastings, dinners and samplings related to the tasting and sales of alcoholic products for others

Class 38

(2) providing access to a website providing commercial information, support and assistance to buyers and distributors of wines, wine based beverages and Grappas

Class 41

(3) educational services in the field of wines, wine based beverages and Grappas, namely organization of tastings, dinners and samplings related to the tasting and sales of alcoholic products for others

Application Number 1,848,980
Language of Application French

Filing Date 2017-07-24

APPLICANT AND AGENT DETAILS

Applicant

ELECTRICITE DE FRANCE
22-30 Avenue de Wagram
75008 Paris
FRANCE

Agent

BCF S.E.N.C.R.L./BCF LLP
1100, boul. René-Lévesque Ouest, 25e Étage,
Montréal, QUÉBEC, H3B5C9

TRADEMARK DETAILS

Trademark Type

Design

Visual Representation



Colour Claim

Colour is claimed as a feature of the trademark. The mark consists of a red-bladed propeller and of the words "EDF" and "Invest" in blue.

Services

Class 36

(1) Financial securities brokerage; insurance services in the field of energy activities and intended for businesses and individuals; insurance services related to the troubleshooting of collective and individual heating, electrical, water, solar, gas, fuel-oil and refrigeration installations; monetary affairs, namely foreign exchange transactions, acquisition and transfer of monetary claims; capital build-up and investment; financial estimates (insurance, banking, real estate); financial and budgetary estimates for energy saving measures; information and data related to the stock market; acquisition of financial interests, namely investment in businesses via the purchase of shares and other securities in the financial, commercial, industrial as well as movable and immovable property fields; build-up and investment of capital; management of financial, stock as well as movable and immovable property portfolios; equity investment activities; financial investment of private equity funds for others; financial management of shares and stocks held in third-party businesses; services for measuring changes and fluctuations in energy commodity prices; stock brokerage in the energy sector; management and appraisal, namely brokerage of carbon credits; financial consulting related to tariff offers in the fields of consumption and energy commodities; provision of information and financial advice to businesses in the field of energy; provision of financial information and advice to consumers in relation to energy; financial consulting for the purchase and selection of electrical apparatus chosen according to criteria related to technical characteristics, cost and energy consumption management; financial analysis for the preselection of products for others and financial consulting in the choice of electrical and industrial equipment likely to meet current standards and regulations; financial information and advice on the cost and operation of electrical apparatus; financial loans in the field of energy installations development

and improvement; financial loans for the acquisition of electrical installations, heating installations and installations powered by all types of energy; financing of energy-saving home renovations; loans for the construction of new energy-saving and environmentally friendly homes; financial estimates to improve the energy, heating and environmental performance of homes and housing stock; financial sponsorship of sports clubs; business intermediary services matching prospective private investors with entrepreneurs seeking financing; financial assistance in the creation of businesses and associations; philanthropic organization offering monetary donations; investment activities related to investment funds; financial analysis, financial advice in the field of cryptocurrency, financial planning and investment consulting services, consulting related to financial investment, consultant services related to the financing of civil engineering work and infrastructure projects, consulting services in the fields of credit and debit control, investment, grants and financing of loans, real estate agencies, real estate appraisals, property evaluation, real estate management.

Class 37

(2) Real estate development.

Claims

Priority Filing Date: January 27, 2017, Country or Office: FRANCE, Application No: 174333267 in association with the same kind of services

Application Number 1,849,443
Language of Application English

Filing Date 2017-07-26

APPLICANT AND AGENT DETAILS

Applicant

Landmark Cinemas Canada Limited
Partnership
Suite 100
14505 Bannister Road SE
Calgary
ALBERTA T2X 3J3

Agent

DENTONS CANADA LLP
2500 Stantec Tower, 10220-103 Avenue NW,
EDMONTON, ALBERTA, T5J0K4

TRADEMARK DETAILS

Landmark Cinemas

Trademark Type

Word

Services

Class 35

(1) Advertising, marketing and promotional services, namely, services of promoting the sale of goods of others through the distribution of printed material and electronic material on the internet, and via radio and television broadcasts and contests on the topics of motion pictures; operation and management of theatres and amusement centres; online sale of movie tickets and gift certificates; online communication services, namely providing information online in the field of promotional events for others through promotional contests and the distribution of related printed and electronic material relating to motion pictures and movie theatre services; provision of information on the topics of promotional events for others through promotional contests and the distribution of related printed and electronic material relating to motion pictures and movie theatre services, via a global computer network

Class 37

(2) Construction and development of theatres and amusement centres

Class 41

(3) Movie theatre services, amusement arcade services; online communication services, namely providing information online in the field of motion pictures; provision of information on the topics of motion pictures, via a global computer network

Class 43

(4) Restaurant, café, snack bar and concession stand services

Application Number 1,849,444
Language of Application English

Filing Date 2017-07-26

APPLICANT AND AGENT DETAILS

Applicant

Landmark Cinemas Canada Limited
Partnership
Suite 100
14505 Bannister Road SE
Calgary
ALBERTA T2X 3J3

Agent

DENTONS CANADA LLP
2500 Stantec Tower, 10220-103 Avenue NW,
EDMONTON, ALBERTA, T5J0K4

TRADEMARK DETAILS

Trademark Type

Design

Visual Representation



Services

Class 35

(1) Advertising, marketing and promotional services, namely, services of promoting the sale of goods of others through the distribution of printed material and electronic material on the internet, and via radio and television broadcasts and contests on the topics of motion pictures; operation and management of theatres and amusement centres; online sale of movie tickets and gift certificates; online communication services, namely providing information online in the field of promotional events for others through promotional contests and the distribution of related printed and electronic material relating to motion pictures and movie theatre services; provision of information on the topics of promotional events for others through promotional contests and the distribution of related printed and electronic material relating to motion pictures and movie theatre services, via a global computer network

Class 37

(2) Construction and development of theatres and amusement centres

Class 41

(3) Movie theatre services, amusement arcade services; online communication services, namely providing information online in the field of motion pictures; provision of information on the topics of motion pictures, via a global computer network

Class 43

(4) Restaurant, café, snack bar and concession stand services

Application Number 1,849,445
Language of Application English

Filing Date 2017-07-26

APPLICANT AND AGENT DETAILS

Applicant

Landmark Cinemas Canada Limited
Partnership
Suite 100
14505 Bannister Road SE
Calgary
ALBERTA T2X 3J3

Agent

DENTONS CANADA LLP
2500 Stantec Tower, 10220-103 Avenue NW,
EDMONTON, ALBERTA, T5J0K4

TRADEMARK DETAILS

Trademark Type

Design

Visual Representation



Colour Claim

Colour is claimed as a feature of the trade-mark. The stars and the swooshes that circle around the words are yellow and the words 'Landmark CINEMAS' are black.

Services

Class 35

(1) Advertising, marketing and promotional services, namely, services of promoting the sale of goods of others through the distribution of printed material and electronic material on the internet, and via radio and television broadcasts and contests on the topics of motion pictures; operation and management of theatres and amusement centres; online sale of movie tickets and gift certificates; online communication services, namely providing information online in the field of promotional events for others through promotional contests and the distribution of related printed and electronic material relating to motion pictures and movie theatre services; provision of information on the topics of promotional events for others through promotional contests and the distribution of related printed and electronic material relating to motion pictures and movie theatre services, via a global computer network

Class 37

(2) Construction and development of theatres and amusement centres

Class 41

(3) Movie theatre services, amusement arcade services; online communication services, namely providing information online in the field of motion pictures; provision of information on the topics of motion pictures, via a global computer network

Class 43

(4) Restaurant, café, snack bar and concession stand services

Application Number 1,849,446
Language of Application English

Filing Date 2017-07-26

APPLICANT AND AGENT DETAILS

Applicant

Landmark Cinemas Canada Limited
Partnership
Suite 100
14505 Bannister Road SE
Calgary
ALBERTA T2X 3J3

Agent

DENTONS CANADA LLP
2500 Stantec Tower, 10220-103 Avenue NW,
EDMONTON, ALBERTA, T5J0K4

TRADEMARK DETAILS

Trademark Type

Design

Visual Representation



Colour Claim

Colour is claimed as a feature of the trade-mark. The words 'Landmark CINEMAS' are white. The stars and the swooshes that circle around the words are yellow. The black background is not part of the mark and is only included to show the placement of the words.

Services

Class 35

(1) Advertising, marketing and promotional services, namely, services of promoting the sale of goods of others through the distribution of printed material and electronic material on the internet, and via radio and television broadcasts and contests on the topics of motion pictures; operation and management of theatres and amusement centres; online sale of movie tickets and gift certificates; online communication services, namely providing information online in the field of promotional events for others through promotional contests and the distribution of related printed and electronic material relating to motion pictures and movie theatre services; provision of information on the topics of promotional events for others through promotional contests and the distribution of related printed and electronic material relating to motion pictures and movie theatre services, via a global computer network

Class 37

(2) Construction and development of theatres and amusement centres

Class 41

(3) Movie theatre services, amusement arcade services; online communication services, namely providing information online in the field of motion pictures; provision of information on the topics of motion pictures, via a global computer network

Class 43

(4) Restaurant, café, snack bar and concession stand services

Application Number 1,849,447
Language of Application English

Filing Date 2017-07-26

APPLICANT AND AGENT DETAILS

Applicant

Landmark Cinemas Canada Limited
Partnership
Suite 100
14505 Bannister Road SE
Calgary
ALBERTA T2X 3J3

Agent

DENTONS CANADA LLP
2500 Stantec Tower, 10220-103 Avenue NW,
EDMONTON, ALBERTA, T5J0K4

TRADEMARK DETAILS

Trademark Type

Design

Visual Representation



Services

Class 35

(1) Advertising, marketing and promotional services, namely, services of promoting the sale of goods of others through the distribution of printed material and electronic material on the internet, and via radio and television broadcasts and contests on the topics of motion pictures; operation and management of theatres and amusement centres; online sale of movie tickets and gift certificates; online communication services, namely providing information online in the field of promotional events for others through promotional contests and the distribution of related printed and electronic material relating to motion pictures and movie theatre services; provision of information on the topics of promotional events for others through promotional contests and the distribution of related printed and electronic material relating to motion pictures and movie theatre services, via a global computer network

Class 37

(2) Construction and development of theatres and amusement centres

Class 41

(3) Movie theatre services, amusement arcade services; online communication services, namely providing information online in the field of motion pictures; provision of information on the topics of motion pictures, via a global computer network

Class 43

(4) Restaurant, café, snack bar and concession stand services

Application Number 1,850,151
Language of Application English

Filing Date 2017-07-31

APPLICANT DETAILS

Applicant

Cristian Tugui
2967 Dundas St. W #991
#991 Toronto
ONTARIO M6P 1Z2

TRADEMARK DETAILS

Trademark Type

Design

Visual Representation



Services

Class 38

streaming of audio and video via the Internet featuring music, movies, news, and sports;

Application Number 1,851,617
Language of Application English

Filing Date 2017-08-08

APPLICANT AND AGENT DETAILS

Applicant

Blackhawk Network, Inc.
6220 Stoneridge Mall Road
Pleasanton, CA 94588
UNITED STATES OF AMERICA

Agent

MLT AIKINS LLP
2100 Livingston Place, 222-3rd Avenue SW,
Calgary, ALBERTA, T2P0B4

TRADEMARK DETAILS

HAWK EARN

Trademark Type

Word

Services

Class 35

(1) Administration of employee, sales force and consumer incentive award programs to incentivize and reward the target audience.

Class 42

(2) Providing temporary use of online non-downloadable computer software for creating, tracking and managing employee, sales force and consumer incentive programs; application service provider (ASP) featuring software in the field of incentive management for use in creating, tracking and managing employee, sales force and consumer incentive programs; software application design and implementation, software application programming and integration and software application maintenance for others in the field of incentive management.

Claims

Priority Filing Date: February 08, 2017, Country or Office: UNITED STATES OF AMERICA,
Application No: 87/329249 in association with the same kind of services

Application Number 1,852,951
Language of Application English

Filing Date 2017-08-17

APPLICANT DETAILS

Applicant

Nutri-Made
37 Tom Wells Cres
Scarborough
ONTARIO M1V 0A5

TRADEMARK DETAILS

Trademark Type

Design

Visual Representation



Disclaimer

The right to the exclusive use of the eleven-point maple leaf is disclaimed apart from the trademark.

Goods

Class 03

(1) Cosmetics, face and skin care products, namely, glacial mud mask, facial masks, facial cream, placenta facial oil, lanolin cream, essential oils, rose essential oil, hair dye and hand cream

Class 05

(2) Dietary supplements consisting of amino acids; food supplements consisting of amino acids; lecithin dietary supplements; mineral nutritional supplements; mineral supplements; vitamin and mineral dietary supplements; vitamin and mineral food supplements; vitamin and mineral supplements; vitamin supplements; Herbal supplements containing ginseng, grape seed extract, blueberry, milk thistle and ginkgo biloba. Food supplements, namely vitamins as gummy candy.

Class 30

(3) Food, namely maple sugar, maple syrup, honey and chocolate

Application Number 1,854,126
Language of Application English

Filing Date 2017-08-24

APPLICANT AND AGENT DETAILS

Applicant

KGHM POLSKA MIEDZ SPÓLKA AKCYJNA
ul. MARII SKŁODOWSKIEJ-CURIE 48
59-301, Lubin
POLAND

Agent

MILTONS IP/P.I.
15 Fitzgerald Rd, Suite 200, Ottawa,
ONTARIO, K2H9G1

TRADEMARK DETAILS

Trademark Type

Design

Visual Representation



Colour Claim

Colour is claimed as a feature of the trade-mark. The colors copper and silver are claimed as features of the trademark. The lower portion of the design element and the letters KGHM are copper. The upper portion of the design element is silver.

Goods

Class 01

(1) Salts of alkaline metals; Salts of precious metals for industrial purposes; Salts from rare earth metals; Rhenium; Selenium; Sulphuric acid

Class 04

(2) Electrical Energy from renewable and non-renewable sources; Mineral motor fuel

Class 06

(3) Common metals and their alloys; Brass, unwrought or semi-wrought; Unwrought lead; Nickel; Cobalt bearing ores, raw; Molybdenum; Cables of metal, non-electric; Copper wire (not insulated); common metals in powder form; Building materials of metal namely boards, panels, cladding, flashing, handrails, linings, partitions, pillars, reinforcement materials, slabs, trim, porches, roof vents and tiles; Ores of metal

Class 14

(4) Precious metals and their alloys; Ingots of precious metals

Services

Class 35

(1) Assistance in management of business management activities; Cost price analysis; Book-keeping; Importexport agency services; Advertising the goods and services of others; Sales of electrical energy, liquid and gas fuels, hot water, steam, salts of alkaline metals, building materials,

metal bearing concentrates and metal ores, chemical products, waste, scrap; Computerized file management; Compilation of information into computer databases; Updating and maintenance of data in computer databases

Class 42

(2) Research in the field of geology, mining, chemistry, biotechnology, biochemistry, engineering, mechanical engineering, building construction, environmental science and product development services; technical consultation in the field of geological mining, technical engineering, environmental science, engineering services and design for others in the field of environmental engineering; Geological prospecting; Chemical research and analysis; Bacteriological research; Providing quality control for the construction industry, mining industry and scientific industry; Research in the field of environmental protection; Computer technology consultancy; Computer software consultancy

Application Number 1,855,015
Language of Application English

Filing Date 2017-08-29

APPLICANT AND AGENT DETAILS

Applicant

Brian Edwards
120-20 Litchfield Crt
Etobicoke
ONTARIO M9V 2A8

Agent

INNOVATE LLP
340 King St. East, Suite 230, Toronto,
ONTARIO, M5A1K8

TRADEMARK DETAILS

GIGME

Trademark Type

Word

Services

Class 41

(1) Arranging music concerts, artist interviews and art shows; arranging venues for music concerts, artist interviews and art shows; entertainment services, namely providing a website featuring music concerts, artist interviews and art shows; providing an online forum to coordinate artists and events; providing an online forum for an artist to promote their work

Class 42

(2) Online archiving and web hosting of entertainment services, namely music concerts, artist interviews and music shows

Application Number 1,855,205
Language of Application English

Filing Date 2017-08-30

APPLICANT AND AGENT DETAILS

Applicant

Vitruvi Corporation
843 Granville Street, Vancouver
BRITISH COLUMBIA V6Z 1K7

Agent

ACCUPRO TRADEMARK SERVICES LLP
SUITE 702 - 401 WEST GEORGIA STREET,
VANCOUVER, BRITISH COLUMBIA, V6B5A1

TRADEMARK DETAILS

Trademark Type

Design

Visual Representation



VITRUVI

Goods

Class 03

(1) Aromatherapy oils in sprays, mists and roll-on applicators; home and body cleaning preparations, namely body scrubs, body lotions, body oils, hair shampoos, countertop spray, kitchen cleaner, namely oven cleaner, glass cleaner, spray cleaner for household purposes, air fragrancing preparations, floor polish;

Class 21

(2) Porcelain aromatherapy diffusers and misters

Application Number 1,857,228
Language of Application English

Filing Date 2017-09-13

APPLICANT AND AGENT DETAILS

Applicant

Ketten-Wulf Betriebs-GmbH
Zum Hohenstein 15
59889 Eslohe-Kückelheim
GERMANY

Agent

NORTON ROSE FULBRIGHT CANADA LLP/S.
E.N.C.R.L., S.R.L.
1, Place Ville Marie, Suite 2500, Montreal,
QUEBEC, H3B1R1

TRADEMARK DETAILS

Trademark Type

Design

Visual Representation



Colour Claim

Colour is claimed as a feature of the trade-mark. The word "Ketten" is in grey, the word "Wulf" is in green, the three upper portions of the design lying under the word "Ketten" are in green, the remaining portion of the design is in grey in which the two circles are in white

Foreign Character Translation

The translation provided by the applicant of the word(s) KETTEN is CHAINS.

Goods

Class 07

(1) Roller chains being parts of machines, conveyor chains, chain wheel, structural parts for all aforementioned goods

Class 12

(2) Transmission chains for vehicles, roller chains for vehicles, conveyor chains for vehicles, drive chains for vehicles, wheel sprockets for vehicles, structural parts for all aforementioned goods

Services

Class 37

(1) Assembly services related to chains, conveyor chains, drive chains, sprockets, and structural parts for all aforementioned goods; assembly services related to chains for vehicles, conveyor chains for vehicles, drive chains for vehicles, sprockets for vehicles, and structural parts for all aforementioned goods; installation, repair and maintenance services related to chains, conveyor chains, drive chains, sprockets, and structural parts for all aforementioned goods; installation, repair and maintenance services related to chains for vehicles, conveyor chains for vehicles, drive chains for vehicles, sprockets for vehicles, and structural parts for all aforementioned goods

Class 40

(2) Customised manufacturing and custom manufacture related to chains, conveyor chains, drive chains, sprockets, and structural parts for all aforementioned goods; customised manufacturing and custom manufacture related to chains for vehicles, conveyor chains for vehicles, drive chains for vehicles, sprockets for vehicles, and structural parts for all aforementioned goods

Class 42

(3) Product development of chains, conveyor chains, drive chains, sprockets, and structural parts for all aforementioned goods; product development of chains for vehicles, conveyor chains for vehicles, drive chains for vehicles, sprockets for vehicles, and structural parts for all aforementioned goods.

Claims

Priority Filing Date: March 20, 2017, Country or Office: GERMANY, Application No: 302017102840.0 in association with the same kind of goods and in association with the same kind of services

Application Number 1,857,395
Language of Application English

Filing Date 2017-09-13

APPLICANT DETAILS

Applicant
IVYCO INTERNATIONAL TRADING LTD
2 Sorrel Crt
TORONTO
ONTARIO M2K 1T7

TRADEMARK DETAILS

IVYCO

Trademark Type
Word

Services

Class 35

Sale of supplements and animal oils and fats for food.

Application Number 1,857,577
Language of Application English

Filing Date 2017-09-14

APPLICANT AND AGENT DETAILS

Applicant

Even Stride, LLC
P.O. Box 10195, Dept. 1173
Palo Alto, CA 94393
UNITED STATES OF AMERICA

Agent

CLARK WILSON LLP
900 - 885 WEST GEORGIA STREET,
VANCOUVER, BRITISH COLUMBIA, V6C3H1

TRADEMARK DETAILS

Trademark Type

Design

Visual Representation

COLERIDGE

Goods

Class 18

(1) Articles for equestrian sports, namely, equine leg wraps, horse bridles, protective plastic hoof pads for horses for the protection of the underside of horses' hoofs, horse tail wraps, training leads for horses, spats and knee bandages for horses, saddles, pads for horse saddles, snaffles, double bridles, halters, bits for horses, horse blankets, saddle cloths, gaiters and knee-pads for horses, fasteners for horse saddles, horseshoes, horse collars, thongs in the nature of thin leather straps for use with horses, leather laces for use with horses, leather straps for use with horses, riding saddles, pads for riding saddles, harness reins and harness traces, horseshoe over-reach boots, fetlock boots; gel cushions, inner soles and gel pads for the protection of horses' hooves; whips; saddlery; saddles; harnesses and bits for animals; protective pads and covers for the hooves, legs, back and tail of a horse for use during transportation and stabling.

Class 25

(2) Clothing, namely, trousers, pants, coats, wind resistant jackets, jackets, jumpers, underwear, socks, stockings, sweaters, polo shirts, t-shirts and skirts all for use in equestrian sports; headgear, namely, cowboy hats, caps and hats for use in equestrian sports not including horseback riding helmets; footwear for use in equestrian sports.

Services

Class 35

(1) Advertising and promotional services for others, namely, promoting the brands, goods, or services of others by arranging for sponsors to affiliate their goods and services with horse expeditions, competitions and events.

Class 41

(2) Entertainment, namely, conducting horse exhibitions, competitions and events; providing information in the field of horse exhibitions, competitions, events, and training.

Class 43

(3) Providing horse stable facilities; boarding for horses.

Claims

Priority Filing Date: August 28, 2017, Country or Office: UNITED STATES OF AMERICA,
Application No: 87586645 in association with the same kind of goods and in association with the same kind of services

Application Number 1,858,146
Language of Application English

Filing Date 2017-09-22

APPLICANT DETAILS

Applicant

Joshua Cooney, individual, Ronald Cooney, individual and Mary-Stella Underwood, individual in a joint venture.

1102 - 55 rue Laframboise
Montréal
QUEBEC H4N 3B7

TRADEMARK DETAILS

MONTREAL GIANTS BASKETBALL

Trademark Type

Word

Disclaimer

The right to the exclusive use of the word MONTREAL and BASKETBALL is disclaimed apart from the trademark.

Goods

Class 14

(1) key-chains

Class 16

(2) banners of paper; posters; trading-cards; calendars; pictures; newsletters; pens namely for writing

Class 18

(3) gym-bags; tote-bags

Class 21

(4) plastic water bottles; coffee-mugs; textile lunch bags

Class 24

(5) banners and flags of textile

Class 25

(6) clothing namely basketball jerseys, shirts, sweat shirts, pull-overs, exercise or sport-shorts, bandannas, caps, winter scarfs, winter hats or toques for both men and women, head-bands, wrist-bands; shoes namely sports

Class 28

(7) sporting goods namely basketballs; bobble-head dolls; action-figures; stuffed toys

Services

Class 35

(1) adult basketball services, namely promoting an adult basketball team either professionally or amateur; promoting an amateur youth basketball team

Class 41

(2) entertainment and educational services in the nature of conducting and arranging basketball clinics, basketball games, basketball competitions and basketball events; adult basketball services, namely forming an adult basketball team either professionally or amateur; amateur youth basketball services, namely organizing and providing youth basketball activities; arranging and conducting youth basketball programs in the nature of basketball skills and development; forming an amateur youth basketball team

Application Number 1,859,533
Language of Application English

Filing Date 2017-09-26

APPLICANT AND AGENT DETAILS

Applicant

AUGUST STORCK KG
Waldstrasse 27, 13403 Berlin
GERMANY

Agent

BAKER & MCKENZIE LLP
BROOKFIELD PLACE, 181 BAY STREET,
SUITE 2100, P.O. BOX 874, TORONTO,
ONTARIO, M5J2T3

TRADEMARK DETAILS

Trademark Type

Design

Visual Representation



Colour Claim

Colour is claimed as a feature of the trade-mark. The letters and the outer border of the letters are in the colour green. The spaces in between the letters and the outer border are white.

Goods

Class 30

(1) Confectionery, namely candies, chewy candy

(2) Confectionery, namely fruit jellies, chewing gum, fruit gum sweets, pastilles, and lollies; chocolate; chocolate products, namely chocolate confectionery, chocolate-covered nuts, chocolate-covered macaroons, chocolate-covered pretzels, and chocolate-covered candy; pastries; ice-cream; preparations for making candies, chewy candy, fruit jellies, chewing gum, fruit gum sweets, pastilles, lollies, chocolate, pastries, icecream and chocolate products, namely chocolate confectionery, chocolate-covered nuts, chocolate-covered macaroons, chocolate-covered pretzels, chocolate-covered candy

Application Number 1,860,337
Language of Application English

Filing Date 2017-09-29

APPLICANT DETAILS

Applicant

Mandip Dhatt
6 Arborview Cres
Etobicoke
ONTARIO M9W 7B4

TRADEMARK DETAILS

Trademark Type

Design

Visual Representation



Goods

Class 16

art pictures; photographs; picture albums; pictures; wedding albums

Services

Class 35

(1) producing promotional videotapes, video discs, and audio visual recordings for others; production of advertising films for others; production of advertising materials for others

Class 40

(2) film development; film development and reproduction of photographs; film processing

Class 42

(3) digitizing of photographs

Application Number 1,860,641
Language of Application English

Filing Date 2017-10-02

APPLICANT AND AGENT DETAILS

Applicant

KyungDong Navien Co., Ltd.
95, Suworam-gil, Seotan-myeon
Pyeongtaek-si, Gyeonggi-do
REPUBLIC OF KOREA

Agent

FASKEN MARTINEAU DUMOULIN LLP
2900 - 550 BARRARD STREET,
VANCOUVER, BRITISH COLUMBIA, V6C0A3

TRADEMARK DETAILS

NAVICLEAN

Trademark Type

Standard Characters

Goods

Class 11

magnetic filter for boilers for removing iron oxide; boilers for household purposes, namely, heating boilers, electric boilers, bath boilers, hot water boilers and laundry room boilers; filters for air purifiers; air filters for industrial purposes, namely, filters for air conditioning, filters for air extractor hoods

Application Number 1,862,168
Language of Application French

Filing Date 2017-10-11

APPLICANT AND AGENT DETAILS

Applicant

Zone3 inc.
1055 boul. René-Lévesque Ouest, bureau
900
Montréal
QUÉBEC H2L 4S5

Agent

BORDEN LADNER GERVAIS LLP
ATTN: INTELLECTUAL PROPERTY
DEPARTMENT, 1000 DE LA GAUCHETIERE
STREET WEST, SUITE 900, MONTREAL,
QUÉBEC, H3B5H4

TRADEMARK DETAILS

LIKE-MOI

Trademark Type

Word

Goods

Class 09

Downloadable application for smart phones, electronic tablets and computers used to provide information about television programs, share information about television programs and television program characters, send text messages, download ringtones for smart phones and disseminate television programs and television program skits.

Services

Class 38

(1) Television programs.

Class 41

(2) Provision of information, namely information about television programs, and entertainment via an interactive website featuring games related to television programs and television program characters and enabling the dissemination of television programs and television program skits; entertainment in the form of non-downloadable television programs broadcast via the Internet.

Application Number 1,864,456
Language of Application French

Filing Date 2017-10-25

APPLICANT AND AGENT DETAILS

Applicant

Renault Trucks Defense (Société par actions simplifiée)
15 Bis Allée des Marronniers
Camp de Satory
78000 Versailles
FRANCE

Agent

BERESKIN & PARR LLP/S.E.N.C.R.L., S.R.L.
SCOTIA PLAZA, 40 KING STREET WEST,
40th FLOOR, TORONTO, ONTARIO, M5H3Y2

TRADEMARK DETAILS

ARQUUS

Trademark Type

Word

Goods

Class 07

(1) Machine tools, in particular machines for the manufacture, servicing and maintenance of land vehicles, amphibious vehicles and weapons, namely engine test benches, tapping machines, folding machines, drills, turning machines; machine coupling and transmission components (except for land vehicles), namely clutch systems, pedals and belts, band brakes for machines for industrial use; power generators, generator sets, auxiliary power units; robots (machines), namely industrial robots, hoisting machines (cranes), bridge construction apparatus, clearing apparatus, namely excavators, bulldozers, land preparation machines and devices, namely ditchers, hydraulic shovels, roller compactors, spare parts, constituent parts and accessories for all of the aforesaid goods.

Class 12

(2) Land vehicles, namely automobiles, trucks, tanks, motor vehicles, civilian vehicles, namely all-terrain and military vehicles, all-terrain vehicles, wheeled and tracked armoured vehicles, wheeled and tracked tanks, vehicles equipped with a weapon system, tank turrets, turrets for armoured vehicles, amphibious vehicles, engineering vehicles, medical vehicles, namely motorized ambulances, recovery vehicles, namely cargo trailers, civil defence vehicles, namely evacuation vans, tankers, vehicle bodies, ballistic protection for armoured vehicles, motors and engines for land vehicles, motor and engine parts for land vehicles; motors and engines for armoured vehicles (except for land vehicles).

Class 13

(3) Firearms, armament systems for armoured vehicles, machine guns, missile launchers, cannons, artillery apparatus, howitzers, gun mounts, remote-controlled turrets, explosives, ammunition, pyrotechnic components, namely cartridges for pyrotechnic products, detonators, detached parts, integral components and accessories for all of the aforesaid goods.

Services

Class 37

Construction, maintenance, renovation and repair of machines and machine parts, namely soldering irons, assembly benches; construction, maintenance, renovation and repair of combat vehicles and components for vehicles and weapon systems, information related to the repair and renovation of vehicles, tire retreading.

Claims

Priority Filing Date: April 27, 2017, Country or Office: FRANCE, Application No: 174357792 in association with the same kind of goods and in association with the same kind of services

Application Number 1,864,978
Language of Application English

Filing Date 2017-10-27

APPLICANT AND AGENT DETAILS

Applicant

CUP & CINO Kaffesystem-Vertrieb GmbH &
Co. KG
Paderborner Str. 33
33161 Hövelhof
GERMANY

Agent

GOWLING WLG (CANADA) LLP
SUITE 1600, 1 FIRST CANADIAN PLACE, 100
KING STREET WEST, TORONTO, ONTARIO,
M5X1G5

TRADEMARK DETAILS

Trademark Type

Design

Visual Representation



Colour Claim

Colour is claimed as a feature of the trademark. The background of the design is black, the words CUP and CINO are white and the & is red.

Goods

Class 11

Indicator lights for use in coffee machines; electronic heaters for water and milk for use in coffee-making machines; steam generating installations; electric cooking utensils; electric refrigerators for use in coffee-making machines; air-conditioning installations for use in coffee-making machines; heater conduits installations as well as cleaning units and metallic filters for use in electric coffee-making machines; electric coffee roasters; coffee making machines.

Application Number 1,866,489
Language of Application French

Filing Date 2017-11-06

APPLICANT AND AGENT DETAILS

Applicant

Les Vêtements Twig Nation S.E.N.C.
338 Ch Du Pré-Vert
Mont-Tremblant
QUÉBEC J8E 2S3

Agent

LAVERY DE BILLY S.E.N.C.R.L.
925, Grande Allée Ouest, Bureau 500,
Québec, QUÉBEC, G1S1C1

TRADEMARK DETAILS

Trademark Type

Design

Visual Representation



Goods

Class 25

Clothing, namely T-shirts, caps, knitted caps, sweatshirts, polo shirts, camisoles, V-neck sweatshirts, long-sleeved sweaters (Henley shirts), buttoned jackets (cardigans).

Application Number 1,867,184
Language of Application English

Filing Date 2017-11-09

APPLICANT AND AGENT DETAILS

Applicant

André Geske
Mühlenkamp 11
32312 Lübbecke
GERMANY

Agent

DALE & LESSMANN LLP
181 UNIVERSITY AVENUE, SUITE 2100,
TORONTO, ONTARIO, M5H3M7

TRADEMARK DETAILS

Trademark Type

Design

Visual Representation

The word "Satisfyer" is written in a highly stylized, cursive script. The letters are interconnected and flow together, with a soft, handwritten appearance. The 'S' is particularly large and loops around the beginning of the word.

Goods

Class 10

Adult sexual stimulation aids, namely, mechanically operated vibrator massagers; vibrators massagers; vibrators for personal use

Application Number 1,869,213
Language of Application English

Filing Date 2017-11-22

APPLICANT DETAILS

Applicant
ED BAKKER
322-1575 Begbie St
Victoria
BRITISH COLUMBIA V8R 1L2

TRADEMARK DETAILS

Trademark Type
Design

Visual Representations

Wild Weather Racquet Skills



Wild Weather Racquet Skills



Colour Claim

Colour is claimed as a feature of the trademark. Color is claimed as a feature of the trademark: where the Lightning Bolt image; has a yellow happy face, where the edge of the face, eyes and smile are all black, and the edge of a yellow bolt is also black, all of which are on a grey background and encircled with a yellow edge; the Raindrop image, has a yellow happy face where the edge of the face, eyes and smile are all black where the rain drop is a dark blue, all of which are on light blue background encircled by a dark blue edge; the Rainbow image has a yellow happy face where the edge of the face, eyes and smile are all black, with a rainbow that follows the pattern of red top arc, then orange arc, then yellow arc, then green arc, then light blue arc, then black arc and finally a purple arc, all of which are on a light green background encircled by a dark green edge.

Goods

Class 09

(1) educational software for children

Class 16

(2) booklets

Class 25

(3) sports clothing

Services

Class 41

tennis instruction

Application Number 1,870,476
Language of Application English

Filing Date 2017-11-29

APPLICANT AND AGENT DETAILS

Applicant

Humii Incorporated
160 Main Street South, Unit 6
Brampton
ONTARIO L6W 2E1

Agent

KATE HENDERSON
128 Vine Avenue, Toronto, ONTARIO, M6P1V7

TRADEMARK DETAILS

DON'T BE LEFT BEHIND

Trademark Type

Word

Services

Class 36

(1) rental of offices for co-working; rental of medical offices for co-working; leasing of office space

Class 42

(2) medical research laboratory services

Class 44

(3) Health care and medical services, namely, the operation of family medicine clinics and walk-in medical clinics, and the provision of specialty medicine practices and services, namely, plastic and cosmetic surgery clinic services, audiology clinics and medical consultancy related to hearing loss, optical laboratories, medical analysis services for diagnostic and treatment purposes provided by medical laboratories, and cardiology, radiology, optometry, and pharmacy clinics and services; telemedicine services; healthcare and medical services, namely, provision of metabolic testing for nutraceutical needs; healthcare and medical services, namely, holistic and naturopathic health assessments and treatments, namely, assessing, treating and counselling patients through the application of naturopathic medicine, natural therapy and naturopathic health care; chiropractic assessments and treatments; operation of medical clinics; physiotherapy treatments and physical rehabilitation; weight loss assessments and prescription and administration of weight loss regimens and exercise programs; food and nutrition consultation services and prescription, administration and supervision of nutrition regimens; prescription of medical exercise, namely, prescription of tailored fitness programs for patients with musculoskeletal, cardiovascular, neurological and metabolic disorders; medical services, namely, providing information in the fields of weight reduction, obesity and the treatment of obesity related diseases; hormone therapy; cosmetic surgery services; provision of cosmetic surgery, massage services, topical cosmetic treatments and skin treatment services, namely, provision of procedures and services for skin tightening, hair removal, skin rejuvenation, cellulite reduction, and body and face contouring, namely, the elimination and reduction of excess skin and fat via surgery and non-surgical methods, namely, low-level laser therapy, suction massage, high-frequency focused ultrasound, and cryolipolysis; intragastric balloon surgery; genetic testing for medical purposes; human fertility testing and treatment services; dentistry services and cosmetic dentistry; laser vision surgery

services; hair replacement; hair implantation; intravenous vitamin, mineral and amino acid infusion therapy; platelet rich plasma (PRP) therapy; cosmetic intradermal injection treatments, namely, botulinum toxin injections, dermal fillers and skin augmenting gel injection treatments;

Application Number 1,870,735
Language of Application English

Filing Date 2017-11-30

APPLICANT AND AGENT DETAILS

Applicant

CoolWhey, Inc.
66 Broadway Ave., #1807
Toronto
ONTARIO M4P 1T6

Agent

FASKEN MARTINEAU DUMOULIN LLP
800 rue Square-Victoria, BUREAU 3700, C.P.
242, MONTREAL, QUEBEC, H4Z1E9

TRADEMARK DETAILS

Trademark Type

Design

Visual Representation



Goods

Class 30

frozen yoghurt; ice cream bars; ice cream sandwiches; ice cream

Application Number 1,871,124
Language of Application English

Filing Date 2017-12-04

APPLICANT AND AGENT DETAILS

Applicant

SODICK CO., LTD.
3-12-1, Nakamachidai
Tsuzuki-ku, Yokohama
Kanagawa 224-8522
JAPAN

Agent

MACRAE & CO.
P.O. BOX 806, STATION B, 222 SOMERSET
STREET WEST, SUITE 600, OTTAWA,
ONTARIO, K2P2G3

TRADEMARK DETAILS

Trademark Type

Design

Visual Representation

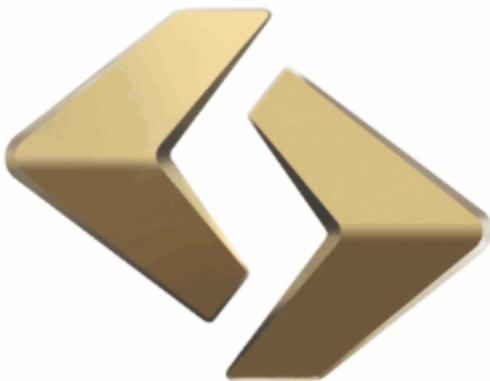

Colour Claim

Colour is claimed as a feature of the trade-mark. The device is gold.

Goods

Class 01

(1) Electric discharge machining (EDM) fluid as a chemical preparation for use in metalworking, and chemical additives thereto; degreasing solvents for use in manufacturing processes; chemical agents for acid removal in industrial manufacturing applications; detergents for industrial use

Class 02

(2) Rust inhibitors for metals

Class 04

(3) Mineral oils and greases for industrial purposes [not for fuel]; electric discharge machining (EDM) oil for use in metalworking; cutting oil for industrial metal working; industrial lubricating oils and greases

Class 07

(4) Metalworking milling machines for metalworking; shaping machines for metalworking; metalworking machine tools; numerical controls for metal working machines; electric discharge machines (EDM) for metalworking, namely, wire EDM, sinker EDM, and small hole drilling EDM; electron beam machines, namely, machines for cutting, polishing, or finishing part of metal and ceramics; metal three dimensional (3D) printers; injection molding machines, namely, plastic injection molding machines and metal injection molding machines; die casting machines; rubber mixing and forming machines; industrial machine presses; semiconductor making machines; food peeling, slicing and mixing machines for industrial use; bottle capping machines for food and beverages; machines for packaging food; noodle making machines; tofu manufacturing machines; pulverizers for food processing; food mixing machines for commercial use; kneading machines; press dies for metal forming; moulds being parts of machines for processing plastics; AC motors and DC motors [not including those for land vehicles but including parts for any AC motors and DC motors]; linear motors; alternating current servo motors; motors and engines used in industrial applications; controllers for motors and engines used in industrial applications; air filters for motors; pipe electrodes for use in electric discharge machining for metalworking; cutting machines for metalworking; cemented carbide cutting tools; diamond-pointed metal-cutting tools

Class 09

(5) Computers; computer numerical controllers for metal working machines; computer software for operating and controlling metal working machines; computer software for computer-aided design /computer-aided manufacturing [CAD/CAM]; remote controls for controlling industrial machinery; magnets for industrial purposes; wire electrodes for use in electric discharge machining for metalworking; high-precision straight edges, squareness, parallelism and precision surface plates for providing an accurate reference plane for metal working machines; light emitting diodes (LEDs); laser diodes; lasers for use in industrial cutting applications; laser measuring tapes; semiconductors; semi-conductor chips; ozonators

Services

Class 37

Repair and maintenance of metalworking machines and tools; repair and maintenance of numerical controls for metal working machines; repair and maintenance of electric discharge machines (EDM); repair and maintenance of machining centers; repair and maintenance of 3D printers; repair and maintenance of metal injection molding machines; repair and maintenance of plastic injection molding machines; repair and maintenance of electric motors and controllers therefor; repair and maintenance of industrial foods or beverage processing machines; repair and maintenance of electrical power distribution machines; repair and maintenance of electronic industrial metalworking machines; repair and maintenance of electric light fixtures.

Application Number 1,872,269
Language of Application English

Filing Date 2017-12-11

APPLICANT AND AGENT DETAILS

Applicant

PROGRESS PROCESS HOLDING
CORPORATION
1707-2975 Atlantic Ave
Coquitlam
BRITISH COLUMBIA V3B 0C5

Agent

JASON D. GOLBEY
(GOLBEY LAW CORPORATION), 2707 Clarke
Street, Port Moody, BRITISH COLUMBIA,
V3H1Z5

TRADEMARK DETAILS

Trademark Type

Design

Visual Representation



Services

Class 35

(1) Providing an on-line searchable database for the sale of goods and services of others;

Class 38

(2) providing on-line interactive bulletin boards for the listing of goods and services of others

Application Number 1,873,002
Language of Application English

Filing Date 2017-12-14

APPLICANT AND AGENT DETAILS

Applicant

ONTEL PRODUCTS CORPORATION
21 Law Drive
Fairfield, NJ 07004
UNITED STATES OF AMERICA

Agent

DICKINSON WRIGHT LLP
199 Bay Street, Suite 2200, P.O. Box 447,
Commerce Court : Postal Station, Toronto,
ONTARIO, M5L1G4

TRADEMARK DETAILS

Trademark Type

Design

Visual Representation



Services

Class 35

Online retail store services featuring a wide variety of consumer products, namely, vacuum cleaners and vacuum cleaner attachments, multi-purpose tape measures, electric brooms, handheld motorized scrubbing brushes and power washers, light bulbs, portable battery-powered lights and lanterns, motion-activated security lights, electric space heaters, cookware and cooking bags for use in microwave ovens, non-electric portable coolers, portable humidifiers and air purifiers, air compressors, medical apparatus and instruments, exercise apparatus, exercise equipment and expanders for therapeutic purposes and rehabilitative purposes, gymnastic and sporting articles, gymnasium equipment, automotive equipment, cleaning products, containers for foods and beverages, eyewear, cosmetics and cosmetic devices, toys and playthings, bedding, hand tools and hand-operated implements for personal purposes, hand-operated food choppers, hand operated food processors, electric hair straightener brushes, haircare products and accessories, floor mats, non-metal clips for securing mobile telephones, personal data assistants (PDAs) and pocket PCs, global positioning system (GPS) receivers, MP3 players and interactive radios (walkie talkies), and clothing.

Application Number 1,873,516
Language of Application English

Filing Date 2017-12-18

APPLICANT AND AGENT DETAILS

Applicant

Ride Control, LLC
39300 Country Club Drive
Farmington Hills, MI 48331
UNITED STATES OF AMERICA

Agent

PERLEY-ROBERTSON, HILL & MCDUGALL
LLP
1400 - 340 ALBERT STREET, OTTAWA,
ONTARIO, K1R0A5

TRADEMARK DETAILS

Trademark Type

Design

Visual Representation



Services

Class 35

Arranging and conducting incentive reward programs to promote the sale of vehicle components, namely, providing loyalty program to businesses to incentivize consumers to purchase vehicle components of others; Providing consumer information services and making referrals in the field of vehicles, namely, automobiles and semi-trailer trucks; Providing consumer information services and making referrals in the field of vehicle repair services

Claims

Priority Filing Date: August 03, 2017, Country or Office: UNITED STATES OF AMERICA,
Application No: 87/555,246 in association with the same kind of services

Application Number 1,874,077
Language of Application English

Filing Date 2017-12-20

APPLICANT AND AGENT DETAILS

Applicant

TRUE NORTH SALMON CO. LTD.
40 Wellington Row
Saint John
NEW BRUNSWICK E2L 3H3

Agent

STEWART MCKELVEY
PURDY'S WHARF TOWER ONE, 1959
UPPER WATER STREET, SUITE 900, P.O.
BOX 997, HALIFAX, NOVA SCOTIA, B3J2X2

TRADEMARK DETAILS

Trademark Type

Design

Visual Representation



Goods

Class 29

seafood, not live; frozen seafood; prepared entrees consisting primarily of seafood; fish

Application Number 1,874,078
Language of Application English

Filing Date 2017-12-20

APPLICANT AND AGENT DETAILS

Applicant

TRUE NORTH SALMON CO. LTD.
40 Wellington Row
Saint John
NEW BRUNSWICK E2L 3H3

Agent

STEWART MCKELVEY
PURDY'S WHARF TOWER ONE, 1959
UPPER WATER STREET, SUITE 900, P.O.
BOX 997, HALIFAX, NOVA SCOTIA, B3J2X2

TRADEMARK DETAILS

Trademark Type

Design

Visual Representation



Goods

Class 29

seafood, not live; frozen seafood; prepared entrees consisting primarily of seafood; fish

Application Number 1,874,482
Language of Application English

Filing Date 2017-12-21

APPLICANT AND AGENT DETAILS

Applicant

Pfizer Inc.
235 East 42nd Street
New York, NY 10017
UNITED STATES OF AMERICA

Agent

TORYS LLP
SUITE 3000, 79 WELLINGTON ST. W., BOX
270, TD CENTRE, TORONTO, ONTARIO,
M5K1N2

TRADEMARK DETAILS

RAYLUMI

Trademark Type

Standard Characters

Goods

Class 05

Pharmaceutical preparations for the prevention and treatment of psychiatric diseases, degenerative nerve diseases and brain disorders, namely, mood, anxiety and cognitive disorders, Alzheimer's disease, cerebral palsy, Parkinson's disease, Huntington's disease and multiple sclerosis, none of the aforementioned for use in embolization, the treatment of circulatory system conditions or the treatment of tumors and arteriovenous malformations (AVMs); Pharmaceutical preparations for the prevention and treatment of cranial and facial nerve disorders, connective tissue injuries, diseases and disorders, bone and cartilage injuries, diseases and disorders, none of the aforementioned for use in embolization, the treatment of circulatory system conditions or the treatment of tumors and arteriovenous malformations (AVMs); Pharmaceutical preparations for the prevention and treatment of neuromuscular and neurological diseases and disorders, namely, central nervous system diseases and disorders, namely central nervous system infections, brain diseases, central nervous system movement disorders, muscle diseases and disorders, namely inflammatory muscle diseases and disorders and muscular dystrophy, ocular motility and spinal cord infections, injuries and diseases, and seizure disorders, none of the aforementioned for use in embolization, the treatment of circulatory system conditions or the treatment of tumors and arteriovenous malformations (AVMs); Pharmaceutical preparations for the prevention and treatment of genitourinary diseases, namely, inflammatory pelvic, vaginitis, dysmenorrhea, cervix erosion, cervicitis, trachelitis, uterine cervicitis, endometriosis, sexually transmitted diseases, erectile and sexual dysfunction, infertility and incontinence, none of the aforementioned for use in embolization, the treatment of circulatory system conditions or the treatment of tumors and arteriovenous malformations (AVMs); Pharmaceutical preparations for the prevention and treatment of cardiovascular, gastrointestinal, blood, oncological, ophthalmological and respiratory system diseases and disorders, none of the aforementioned for use in embolization, the treatment of circulatory system conditions or the treatment of tumors and arteriovenous malformations (AVMs); Pharmaceutical preparations for the prevention and treatment of auto-immune diseases and disorders, namely collagen disease, rheumatoid arthritis, systemic lupus erythematosus, alopecia areata, and systemic sclerosis, none of the aforementioned for use in embolization, the treatment of circulatory system conditions or the treatment of tumors and arteriovenous malformations (AVMs); Pharmaceutical preparations for the prevention and treatment of allergies,

hypertension, menopause, diabetic neuropathy, arthritis, and pain, none of the aforementioned for use in embolization, the treatment of circulatory system conditions or the treatment of tumors and arteriovenous malformations (AVMs); Antibiotics, anti-infectives, anti-inflammatories, anti-fungals, anti-virals, oral and injectable pharmaceutical contraceptives, human vaccines, none of the aforementioned for use in embolization, the treatment of circulatory system conditions or the treatment of tumors and arteriovenous malformations (AVMs); Pharmaceutical preparations for the prevention and treatment of smoking habits and addictions, none of the aforementioned for use in embolization, the treatment of circulatory system conditions or the treatment of tumors and arteriovenous malformations (AVMs); Pharmaceutical preparations for the prevention and treatment of renal disease and disorders, none of the aforementioned for use in embolization, the treatment of circulatory system conditions or the treatment of tumors and arteriovenous malformations (AVMs); Pharmaceutical preparations for the prevention and treatment of diseases, disorders and infections of the endocrine system, namely growth and thyroid disorders, none of the aforementioned for use in embolization, the treatment of circulatory system conditions or the treatment of tumors and arteriovenous malformations (AVMs); Pharmaceutical preparations for the prevention and treatment of muscular atrophy, none of the aforementioned for use in embolization, the treatment of circulatory system conditions or the treatment of tumors and arteriovenous malformations (AVMs); Pharmaceutical preparations for the prevention and treatment of inflammatory diseases, namely inflammatory bowel diseases, inflammatory joint diseases, inflammatory connective tissue diseases, inflammatory muscle diseases and disorders, none of the aforementioned for use in embolization, the treatment of circulatory system conditions or the treatment of tumors and arteriovenous malformations (AVMs); Pharmaceutical preparations for the prevention and treatment of metabolic diseases and disorders, namely diabetes, hypoglycemia, muscular dystrophy, sickle cell disease, non-alcoholic steatohepatitis and anemia, none of the aforementioned for use in embolization, the treatment of circulatory system conditions or the treatment of tumors and arteriovenous malformations (AVMs); Pharmaceutical preparations for the prevention and treatment of dermatological diseases and conditions, namely eczema, atopic dermatitis, psoriasis, bacterial skin infections, fungal skin infections, viral skin infections, parasitic skin infections, acne, pyoderma, erosion, ulcer, trauma, burned skin, pain and inflammation, none of the aforementioned for use in embolization, the treatment of circulatory system conditions or the treatment of tumors and arteriovenous malformations (AVMs).

Application Number 1,874,875
Language of Application English

Filing Date 2017-12-22

APPLICANT AND AGENT DETAILS

Applicant

BRAND BOX S.R.L.
Via Cascina Lari 20
San Miniato (Pisa)
ITALY

Agent

ROBIC
630, boul. René-Lévesque Ouest, 20e étage,
Montréal, QUEBEC, H3B1S6

TRADEMARK DETAILS

Trademark Type

Design

Visual Representation

 ARKISTAR

Goods

Class 18

(1) Travelling cases of leather; credit card cases of leather; leather key cases; key cases of imitation leather; travel bags; travel baggage; trunks, being luggage; travelling trunks; footlockers; vanity cases sold empty; bags, namely, shoulder bags, barrel bags, wheeled bags, beach bags, bags for sports; travelling bags, being leatherware; leather bags; gentlemen's handbags; drawstring bags; small bags for men; bags for sports clothing; leather shopping bags; handbags; reticules; duffle bags for travel; holdalls for sports clothing; pouches for holding make-up, keys and other personal items; bags for umbrellas; carrying cases for documents; name card cases; hip bags; clutch bags; key cases of skins; folding briefcases; duffle bags; pouches of leather; attaché cases; attaché cases of imitation leather; overnight suitcases; suitcases; leather suitcases; daypacks; rucksacks; luggage; all-purpose carrying bags.

Class 25

(2) Clothing of leather or imitations of leather, namely, jackets, trousers, shirts, skirts and vests; woollen clothing, namely, sweaters, hats, socks and tights; denims, namely denim jackets, denim jeans, denim shirts; cashmere clothing, namely, cardigans, coats, sweatshirts, jackets, sweaters, trousers, pullovers and t-shirts; silk clothing, namely, jackets, sweaters, neckties, scarves and shawls; outdoor clothing, namely gloves and mittens; leisure suits; suits; weatherproof clothing, namely, jackets and pants; pinstripe suit; dresses made from skins; three-piece suits, being clothing; gowns; blouses; clothing for children, namely, pajamas, jackets, shirts, pants, jumpers; ballet flats; bandanas, being neckerchiefs; blazers; bodysuits; bomber jackets; footwear for men and women namely shoes, sneakers, sandals, flip-flops, socks; footwear and boots for children; casual footwear; footwear made of wood namely wooden shoes; footwear, not for sports namely casual shoes, dress shoes, leather shoes; athletic footwear; infants' footwear; footwear for sports; shirts; long-sleeved shirts; short-sleeve shirts; tank tops; sports vests; windproof clothing, namely, wind-jackets, coats, shirts, suits, pants; fur hats; rain hats; woollen hats; coats; leather coats; fur coats; coats made of cotton; denim coats; hoods, being clothing; cardigans; waist belts, being

clothing; shoe straps; belts, being clothing; belts made from imitation leather; textile belts, being clothing; leather belts, being clothing; money belts, being clothing; neck bands, being parts of clothing; dress suits; men's suits; rain suits; layette , being clothing; beach clothes, namely, coverups, dresses and pareos; neckerchiefs; sweatshirts; hooded sweatshirts; foulards, being clothing articles; jackets, being clothing; wind vests; quilted vests; blousons; sleeveless jackets; skirts; overalls; gloves, being clothing; mittens; winter gloves; ready-made clothing, namely, jackets, sport coats, pants, short pants and shirts; knitwear, being clothing namely knit hats, knit jackets, knit tops, knitted gloves; jeans; flip-flops, being footwear; jerseys, being clothing namely sports jerseys; leggings, being leg warmers; V-neck sweaters; turtleneck sweaters; hosiery; sweaters; muffs, being clothing; fur cloaks; vests; trousers; slippers; ear muffs, being clothing; parkas; balaclavas; pelisses; dickeys, being shirt fronts; ponchos; sunsuits; crew neck sweaters; long-sleeved sweaters; slipovers; sandals; bath sandals; shoes; bath slippers; running shoes; shoes for women; gymnastic shoes; training shoes; leather shoes; canvas shoes; rubber shoes; shawls; scarves; tuxedos; shorts; inner soles; overcoats; outerclothing, namely, aprons, capes, jerkins, pea coats, raincoats, shrugs, sport coats, waistcoats, windbreakers; petticoats; boots; halfboots; lace boots; stoles; soles for footwear; shoe soles; slipper soles; tailleurs; heels; pockets for clothing; tops, being clothing namely sweat tops, woven tops, hooded tops; trench coats; tracksuits; combinations, being clothing namely body suits, coveralls; twinsets; dressing gowns; veils, being clothing; wooden shoes.

Claims

Priority Filing Date: July 11, 2017, Country or Office: ITALY, Application No: 302017000077631 in association with the same kind of goods

Application Number 1,875,334
Language of Application English

Filing Date 2017-12-28

APPLICANT AND AGENT DETAILS

Applicant

Toplan Co., Ltd.
13, Neunggil-ro 115beon-gil
Danwon-gu, Ansan-si
Gyeonggi-do
REPUBLIC OF KOREA

Agent

BERESKIN & PARR LLP/S.E.N.C.R.L., S.R.L.
SCOTIA PLAZA, 40 KING STREET WEST,
40th FLOOR, TORONTO, ONTARIO, M5H3Y2

TRADEMARK DETAILS

Toplan

Trademark Type

Word

Goods

Class 10

Dental instruments; dental foundation supports; dental bone screws; dental dams; drills for dental applications; surgical instruments for dental use; dental operating units, namely, dental lamps; dental implants; implant fixture for dental purposes; implant bridges for dental purposes; implant surgical instruments for dental purposes; implant screws taps for dental purposes; implant extenders for dental purposes; implant abutment for dental purposes; dental crowns; dental caps

Services

Class 35

Wholesale store services featuring dental instruments; retail store services featuring dental instruments; wholesale store services featuring dental screws; retail store services featuring dental screws; sales agency services for dental screws; wholesale store services featuring drills for dental applications; wholesale store services featuring drilling jigs for dental applications; retail store services featuring drilling jigs for dental applications; retail store services featuring drills for dental applications; wholesale store services featuring instruments for use in prosthetic dentistry; retail store services featuring instruments for use in prosthetic dentistry; wholesale store services featuring surgical instruments for dental use; retail store services featuring surgical instruments for dental use; wholesale store services featuring implant fixture for dental purposes; retail store services featuring implant fixture for dental purposes; wholesale store services featuring dental implants; retail store services featuring dental implants

Claims

Priority Filing Date: July 03, 2017, Country or Office: REPUBLIC OF KOREA, Application No: 40-2017-0082179 in association with the same kind of services; July 03, 2017, Country or Office: REPUBLIC OF KOREA, Application No: 40-2017-0082178 in association with the same kind of goods

Application Number 1,876,961
Language of Application English

Filing Date 2018-01-11

APPLICANT AND AGENT DETAILS

Applicant

Valley Agricultural Software
3950 South K Street
Tulare, CA 93274
UNITED STATES OF AMERICA

Agent

OSLER, HOSKIN & HARCOURT LLP
SUITE 1900, 340 ALBERT STREET,
OTTAWA, ONTARIO, K1R7Y6

TRADEMARK DETAILS

Trademark Type

Design

Visual Representation



Colour Claim

Colour is claimed as a feature of the trademark. The trademark is moss green (C50 M15 Y25 K30), olive (C45 M10 Y90 K0) and green yellow (C20 M0 Y100 K0).

Goods

Class 09

Computer software and computer hardware for use in dairy herd management and monitoring; Computer software and computer hardware for use in data entry and monitoring of daily tasks in the field of dairy herd management; Computer software and computer hardware for use in management and monitoring of milking parlors and measuring milk production on dairy farms; Computer software and computer hardware for use in managing animal feed and animal feeding systems on dairy farms.

Application Number 1,877,282
Language of Application English

Filing Date 2018-01-12

APPLICANT AND AGENT DETAILS

Applicant

Asymptote Limited
Sovereign House
Chivers Way, Histon
Cambridge CB24 9BZ
UNITED KINGDOM

Agent

BERESKIN & PARR LLP/S.E.N.C.R.L., S.R.L.
SCOTIA PLAZA, 40 KING STREET WEST,
40th FLOOR, TORONTO, ONTARIO, M5H3Y2

TRADEMARK DETAILS

ICESTART

Trademark Type

Word

Goods

Class 01

(1) Chemical nucleation preparations for scientific use, namely, for maintaining cell viability following freezing and thawing.

Class 05

(2) Chemical ice nucleation preparations for medical use, namely, for maintaining cell viability following freezing and thawing.

Claims

Priority Filing Date: July 13, 2017, Country or Office: UNITED KINGDOM, Application No: 3243495 in association with the same kind of goods

Application Number 1,877,549
Language of Application English

Filing Date 2018-01-15

APPLICANT AND AGENT DETAILS

Applicant

Cloudy Sundays Corp.
180 Ragged Point Rd
Saint John
NEW BRUNSWICK E2K 5C4

Agent

AARON M. SAVAGE
(COX & PALMER), 77 WESTMORLAND
STREET, SUITE 300, FREDERICTON, NEW
BRUNSWICK, E3B6Z3

TRADEMARK DETAILS

Trademark Type

Design

Visual Representation



Foreign Character Translation

The translation provided by the applicant of the Irish word(s) is LAND OF YOUTH.

Goods

Class 16

(1) Notepads

Class 25

(2) Clothing and merchandise, namely, t-shirts, sweatshirts and jackets

Services

Class 35

(1) Advice in the running of establishments as franchises related to outdoor early childhood education.

Class 39

(2) Outdoor excursions, namely, wilderness tour guides, hiking expeditions, camping expeditions, wildlife watching expeditions and nature interpretation expeditions

Class 41

(3) Summer camps consisting of classes and workshops related to outdoor early childhood education and environmental awareness, environmental issues, fitness and nutrition, personal development and wellness, arts and crafts, children's entertainment and recreational activities

(4) Education and training services for teachers and public and private sector professionals, namely, providing classes, seminars, workshops in the field of leadership development, personal and professional development, and environmental conservation and preservation

Application Number 1,877,555
Language of Application English

Filing Date 2018-01-15

APPLICANT AND AGENT DETAILS

Applicant

Cloudy Sundays Corp.
180 Ragged Point Rd
Saint John
NEW BRUNSWICK E2K 5C4

Agent

AARON M. SAVAGE
(COX & PALMER), 77 WESTMORLAND
STREET, SUITE 300, FREDERICTON, NEW
BRUNSWICK, E3B6Z3

TRADEMARK DETAILS

Tir na nÓg Forest School

Trademark Type

Word

Foreign Character Translation

The translation provided by the applicant of the Irish word(s) is LAND OF YOUTH.

Goods

Class 16

(1) Notepads

Class 25

(2) Clothing and merchandise, namely, t-shirts, sweatshirts, jackets

Services

Class 35

(1) Advice in the running of establishments as franchises related to outdoor early childhood education

Class 39

(2) Outdoor excursions, namely, wilderness tour guides, hiking expeditions, camping expeditions, wildlife watching expeditions and nature interpretation expeditions

Class 41

(3) Summer camps consisting of classes and workshops related to outdoor early childhood education and environmental awareness, environmental issues, fitness and nutrition, personal development and wellness, arts and crafts, children's entertainment and recreational activities

(4) Education and training services for teachers and public and private sector professionals, namely, providing classes, seminars, workshops in the fields of leadership development, personal and professional development, and environmental conservation and preservation

Application Number 1,877,618
Language of Application English

Filing Date 2018-01-15

APPLICANT AND AGENT DETAILS

Applicant

TOP Informatie Systemen B.V.
Westlandseweg 40
2624 AD DELFT
NETHERLANDS

Agent

GOWLING WLG (CANADA) LLP
550 BURRARD STREET, SUITE 2300,
VANCOUVER, BRITISH COLUMBIA, V6C2B5

TRADEMARK DETAILS

Trademark Type

Design

Visual Representation



Colour Claim

Colour is claimed as a feature of the trademark. The top triangular portion of the arrow design is dark red (Pantone* 485 U + 633, 35 percent multiplied), the lower portion of the arrow is light red (Pantone* 485 U) and the word TOPdesk is light blue (Pantone* 633U). *Pantone is a registered trade-mark

Goods

Class 09

Software, namely service Managements software for use in the field of IT, facilities management and e-HRM help desk, for organizing incoming calls, service tracking, namely monitoring and enforcing customer service performance standards, billing and invoicing, inventory control, client relationship management, remote monitoring of hardware and database management

Services

Class 42

Computer programming; computer programming for the purpose of the support of helpdesk divisions; automation services, namely consultation in the field of IT, facilities management and e-HRM help desk, namely remote monitoring of hardware and database management and software development for business and individuals in the field of IT, facilities management and e-HRM; automation services, namely analysis and troubleshooting of computer hardware and software problems; installation, maintenance and updating of software for third party's computer systems and networks

Application Number 1,877,714
Language of Application English

Filing Date 2018-01-16

APPLICANT AND AGENT DETAILS

Applicant

Abdij Sint-Sixtus, Vereniging zonder
winstoogmerk (Association without
lucrative purpose)
Donkerstraat 12
8640 Westvleteren
BELGIUM

Agent

ROBIC
630, boul. René-Lévesque Ouest, 20e étage,
Montréal, QUEBEC, H3B1S6

TRADEMARK DETAILS

Trademark Type

Design

Visual Representation



Colour Claim

Colour is claimed as a feature of the Trademark. The mark consists of a shield outlined in black. The top of the shield is green with two white keys crossing. The bottom of the shield is white with a green tree, and two parallel half circle outlines at the bottom of the tree that are also green. The top of the shield has an ornamental design coming out of it in black. Above the shield are the words "ABDIJ", "ST." and "SIXTUS" in white and outlined in black. Under the shield is the word "WESTVLETEREN" in white and outlined in black. The entire logo is outlined by an unfinished square shape that consists of four black outlines on each side and four white corners outlined in black.

Foreign Character Translation

The translation provided by the applicant of the words ABDIJ ST. SIXTUS is ABBEY ST. SIXTUS and ABBAYE ST. SIXTUS.

Goods

Class 32

beers

Application Number 1,878,645
Language of Application English

Filing Date 2018-01-22

APPLICANT DETAILS

Applicant

SHENZHEN XIN CAI DA TECHNOLOGY CO.
LTD
5194 Killarney Street
Vancouver
BRITISH COLUMBIA V5R 3V9

TRADEMARK DETAILS

Lunvon

Trademark Type

Word

Goods

Class 20

(1) Bedroom furniture; dining room furniture; living room furniture; office furniture; plastic recycling bins for commercial use; mirrors; bamboo; works of art of nutshell; display boards; decorations of plastic for foodstuffs; nesting boxes for household pets; non-metal nameplates; funerary urns; plastic coathooks; cushions; pillows; curtain rings

Class 21

(2) Thermal insulated containers for food or beverages; drinking flasks; ceramic jugs; ceramic mugs; china ornaments; drinking cups; drinking glasses; dispensers for paper towels; perfume burners; combs for back-combing hair; hair brushes; toothbrushes; toothpicks; cosmetic brushes; vacuum bottles; dusting cloths; crystal ornaments; drinking troughs; indoor terrariums; fly swatters; plug-in diffusers for mosquito repellents.

Class 28

(3) Playing balls; stationary exercise bicycles; rowing exercise machines; surfboards; hunting game calls; children's inflatable swimming pools; shin guards for athletic use; ice skates; Christmas tree ornaments; fishing tackle; camouflage screens.

Application Number 1,878,879
Language of Application English

Filing Date 2018-01-22

APPLICANT AND AGENT DETAILS

Applicant

WALK-ON'S ENTERPRISES IP, LLC
3960 Burbank Drive
Baton Rouge, Louisiana 70808
UNITED STATES OF AMERICA

Agent

BORDEN LADNER GERVAIS LLP
World Exchange Plaza, 100 Queen Street,
Suite 1300, Ottawa, ONTARIO, K1P1J9

TRADEMARK DETAILS

WALK-ON'S BISTREAUX & BAR

Trademark Type

Standard Characters

Goods

Class 25

Clothing and wearing apparel, namely, shirts, polo shirts, scarfs, jackets, wind shirts, sweatpants, caps being headwear, hats, shorts, sweatshirts, t-shirts, tank tops, underwear, sun visors, visors for athletic use.

Services

Class 43

Restaurant and bar services; catering services.

Claims

Priority Filing Date: January 22, 2018, Country or Office: UNITED STATES OF AMERICA,
Application No: 87/764,708 in association with the same kind of goods and in association with the same kind of services

Application Number 1,878,903
Language of Application English

Filing Date 2018-01-22

APPLICANT AND AGENT DETAILS

Applicant

OrVance, LLC
6477 Cherry Meadow Drive SE
Suite 5
Caledonia, Michigan, 49316
UNITED STATES OF AMERICA

Agent

RIDOUT & MAYBEE LLP
11 Holland Avenue, Suite 601 , Ottawa,
ONTARIO, K1Y4S1

TRADEMARK DETAILS

OrVance

Trademark Type

Standard Characters

Goods

Class 10

Orthodontic appliances

Application Number 1,879,500
Language of Application English

Filing Date 2018-01-25

APPLICANT AND AGENT DETAILS

Applicant

Valley Agricultural Software
3950 South K Street
Tulare, CA 93274
UNITED STATES OF AMERICA

Agent

OSLER, HOSKIN & HARCOURT LLP
SUITE 1900, 340 ALBERT STREET,
OTTAWA, ONTARIO, K1R7Y6

TRADEMARK DETAILS

Trademark Type

Design

Visual Representation



Colour Claim

Colour is claimed as a feature of the trademark. The trademark is moss green (C50 M15 Y25 K30), olive (C45 M10 Y90 K0) and green yellow (C20 M0 Y100 K0).

Services

Class 42

Technical support services in the form of troubleshooting of computer hardware and software problems and repair and maintenance services for computer software; development of computer hardware, computer software and computer software applications for dairy operations and dairy developments.

Application Number 1,879,611
Language of Application English

Filing Date 2018-01-25

APPLICANT AND AGENT DETAILS

Applicant

UNITE EUROTHERAPY, INC.
2870 Whiptail Loop East
Suite 100
Carlsbad, CA 92010
UNITED STATES OF AMERICA

Agent

BERESKIN & PARR LLP/S.E.N.C.R.L., S.R.L.
SCOTIA PLAZA, 40 KING STREET WEST,
40th FLOOR, TORONTO, ONTARIO, M5H3Y2

TRADEMARK DETAILS

BOOSTA

Trademark Type

Word

Goods

Class 03

- (1) Hair care products, namely, shampoos, conditioners
- (2) Hair styling creams

Claims

Priority Filing Date: August 31, 2017, Country or Office: UNITED STATES OF AMERICA,
Application No: 87591996 in association with the same kind of goods (1)

Application Number 1,879,710
Language of Application English

Filing Date 2018-01-26

APPLICANT AND AGENT DETAILS

Applicant

IMS GEAR SE & Co. KGaA
Heinrich-Hertz-Straße 16
78166 Donaueschingen
GERMANY

Agent

AVENTUM IP LAW LLP
SUITE 830, TOWER B, , 555 LEGGET DRIVE,
OTTAWA, ONTARIO, K2K2X3

TRADEMARK DETAILS

IMS.services

Trademark Type

Word

Services

Class 42

Quality testing for toothed wheels and transmissions, engineering in relation to gear technology, in particular for auxiliary drives for motor vehicles

Claims

Priority Filing Date: July 26, 2017, Country or Office: EUIPO (EU), Application No: 017040643 in association with the same kind of services

Application Number 1,880,116
Language of Application English

Filing Date 2018-01-29

APPLICANT AND AGENT DETAILS

Applicant

Elizabeth Jocelyn Mascull and Roger Thomas
Mascull as Trustees for the RT and EJ Family
Trust
32 Detroit Drive
Izone Business Hub
Rolleston 7675
NEW ZEALAND

Agent

OTTO ZSIGMOND
(NEXUS LAW GROUP LLP), Suite 1140 - 625
Howe Street, P.O. Box: 9, Vancouver, BRITISH
COLUMBIA, V6C2T6

TRADEMARK DETAILS

Trademark Type

Design

Visual Representation

Goods

Class 10

(1) Medical and orthopaedic apparatus namely, therapeutic seats, tables, beds, mattresses, pillows, walking frames, walkers, gait trainers, cushions, forearm supports, arm supports, knee supports, backrests, trunk supports in the nature of torso supports, head supports, pelvic supports, thigh supports, lower leg supports and foot supports; Orthopedic cushions and padding; Stands and supports for use with feeding in the nature of standing frames and sitting frames for upright positioning of disabled persons; Postural care and support devices, namely, adjustable belts and harnesses to correct one's posture for medical and orthopedic purposes; Restraints, belts and harnesses for postural care and support

Class 12

(2) Wheelchairs, parts and fittings for wheelchairs, prams, parts and fittings for prams, harnesses for wheelchairs and prams; Seats for wheelchairs; Pads for wheelchair seats

Claims

Priority Filing Date: November 13, 2017, Country or Office: NEW ZEALAND, Application No: 1080592 in association with the same kind of goods

Application Number 1,880,117
Language of Application English

Filing Date 2018-01-29

APPLICANT AND AGENT DETAILS

Applicant

Elizabeth Jocelyn Mascull and Roger Thomas
Mascull as Trustees for the RT and EJ Family
Trust
32 Detroit Drive
Izone Business Hub
Rolleston 7675
NEW ZEALAND

Agent

OTTO ZSIGMOND
(NEXUS LAW GROUP LLP), Suite 1140 - 625
Howe Street, P.O. Box: 9, Vancouver, BRITISH
COLUMBIA, V6C2T6

TRADEMARK DETAILS

Trademark Type

Design

Visual Representation



Goods

Class 10

(1) Medical and orthopaedic apparatus, namely, therapeutic seats, tables, beds, mattresses, pillows, walking frames, walkers, gait trainers, cushions, forearm supports, arm supports, knee supports, backrests, trunk supports in the nature of torso supports, head supports, pelvic supports; thigh supports, lower leg supports and foot supports; Orthopedic cushions and padding; Stands and supports for use with feeding in the nature of standing frames and sitting frames for upright positioning of disabled persons; Postural care and support devices, namely, adjustable belts and harnesses to correct one's posture for medical and orthopedic purposes; Restraints, belts and harnesses for postural care and support

Class 12

(2) Wheelchairs, parts and fittings for wheelchairs, prams, parts and fittings for prams, harnesses for wheelchairs and prams; Seats for wheelchairs; Pads for wheelchair seats

Claims

Priority Filing Date: November 13, 2017, Country or Office: NEW ZEALAND, Application No: 1080593 in association with the same kind of goods

Application Number 1,880,470
Language of Application English

Filing Date 2018-01-30

APPLICANT AND AGENT DETAILS

Applicant

Shenzhen Tuoja Technology Co., Ltd.
Rm. 804, Yuanmeng Tech. Bldg., Minle
Tech Park
Bantian Blvd., Minzhi St., Longhua
Dist.,
Shenzhen, Guangdong
CHINA

Agent

XIN XU
(JONES & CO.), 67 Yonge Street, Suite 602,
TORONTO, ONTARIO, M5E1J8

TRADEMARK DETAILS

Toplus

Trademark Type

Word

Goods

Class 03

(1) cosmetic kits

Class 09

(2) bathroom scales; cabinets for loudspeakers; camera brackets; cases for mobile phones; computer stands; electric door bells; laboratory scales and balances; medical scales; plug-in connectors; protective films adapted for smart phones; uninterruptible power supplies; voltage stabilizing power supply

Class 10

(3) thermometers for medical purposes

Class 11

(4) electric lamps; headlights for automobiles; sun lamps

Class 12

(5) ashtrays for automobiles; automobile windshield sunshades; sun shields and visors for motor cars; vehicle windshield sunshades

Class 20

(6) bamboo curtains; pillows

Class 21

(7) bottle openers; cruets; hand-operated coffee grinders and pepper mills; ice cube moulds; insect traps; make-up brushes; mouse traps

Class 24

(8) bath towels; beach towels; bed covers; face towels of textiles; pillowcases; quilts of textile; tricot quilts

Class 27

(9) yoga mats

Class 28

(10) educational toys; infant toys; knee pads for athletic use; mechanical toys; rhythmic gymnastic hoops; sports weight lifting belts; yoga straps

Application Number 1,880,539
Language of Application English

Filing Date 2018-01-31

APPLICANT DETAILS

Applicant
NOAM URIM ENTERPRISES (1993) LTD
kibbutz URIM
LTD Kibbutz Urim M.P. Negev 85530
Israel
ISRAEL

TRADEMARK DETAILS

Trademark Type
Design

Visual Representation



Colour Claim

Colour is claimed as a feature of the mark; the design and the word DINICLEAN are blue; the background is white.

Goods

Class 03

Body sponges impregnated with soap

Application Number 1,880,848
Language of Application English

Filing Date 2018-02-01

APPLICANT AND AGENT DETAILS

Applicant

Philipp Pietsch
Alter Traßweg 19 A
D-51427 Bergisch Gladbach
GERMANY

Agent

GOWLING WLG (CANADA) LLP
SUITE 1600, 1 FIRST CANADIAN PLACE, 100
KING STREET WEST, TORONTO, ONTARIO,
M5X1G5

TRADEMARK DETAILS

GERMANUS

Trademark Type

Word

Goods

Class 16

(1) Leather pencil cases; Pencil boxes; Leather appointment book covers; Leather covered diaries; Writing tablets; Desk organisers.

Class 18

(2) Leather and imitation leather; Travel luggage; Bags of leather, imitation leather and cork leather; Umbrellas; Parasols; Walking sticks; Saddlery.

Class 34

(3) Tobacco, Matches; Ashtrays; Matchboxes; Match holders; Cigars; Cigar cutters; Cigar cases; Cigar boxes; Cigar boxes (with humidor); cigar scissors; Cigar holders; Absorbent paper for tobacco pipes; Chewing tobacco; Snuff; Snuff boxes; Spittoons for tobacco users; Tobacco pouches; Tobacco jars; Electronic cigarettes; Mouthpieces for cigarette holders; Pocket machines for rolling cigarettes; Cigarettes; Cases for cigarettes; Cigarette cases; Cigarette filters; Cigarette tips; Cigarette paper; Books of cigarette papers; Cigarette holders; Cigarettes containing herbal molasses as a tobacco substitute, herbs for use as tobacco substitutes; Lighters for smokers; smoking pipes, tobacco pipes, electronic smoking pipes; Pipe cleaners for tobacco pipes; Pipe racks for tobacco pipes.

Claims

Priority Filing Date: August 23, 2017, Country or Office: EUIPO (EU), Application No: 017137894 in association with the same kind of goods

Application Number 1,881,171
Language of Application English

Filing Date 2018-02-02

APPLICANT AND AGENT DETAILS

Applicant

Uchida of America, Corp.
3535 Del Amo Blvd.
Torrance, CA 90503
UNITED STATES OF AMERICA

Agent

MARKS & CLERK
180 KENT STREET, SUITE 1900, P.O. BOX
957, STATION B, OTTAWA, ONTARIO,
K1P5S7

TRADEMARK DETAILS

FABRI-INK

Trademark Type

Word

Goods

Class 16

Fabric markers

Claims

Priority Filing Date: September 20, 2017, Country or Office: UNITED STATES OF AMERICA,
Application No: 87/616,289 in association with the same kind of goods

Application Number 1,881,765
Language of Application English

Filing Date 2018-02-06

APPLICANT AND AGENT DETAILS

Applicant

MEDICE Arzneimittel Pütter GmbH & Co. KG
Kuhloweg 37
58638 Iserlohn
GERMANY

Agent

OYEN WIGGS GREEN & MUTALA LLP
480-THE STATION, 601 WEST CORDOVA
STREET, VANCOUVER, BRITISH
COLUMBIA, V6B1G1

TRADEMARK DETAILS

Trademark Type

Design

Visual Representation



Goods

Class 05

Medicine for human use for the treatment of the central nervous system, namely, for the treatment of encephalitis, epilepsy, Alzheimer's, cerebral palsy, Parkinson's disease, central nervous system infections, brain diseases, central nervous system movement disorders, attention deficit hyperactivity disorder, depression, anxiety, psychosis, substance use disorder, ocular motility disorders, spinal cord diseases, stroke; Medicine for human use for the treatment of internal disease, namely, for the treatment of renal insufficiency, bladder disorders, anemia, hypertension, hyperphosphatemia, fatigue syndrome, vitamin deficiency, atherosclerosis, diabetes, ischemia.

Application Number 1,881,900
Language of Application English

Filing Date 2018-02-07

APPLICANT AND AGENT DETAILS

Applicant

ALNYLAM PHARMACEUTICALS, INC.
300 Third Street
Cambridge, MA 02142
UNITED STATES OF AMERICA

Agent

MACRAE & CO.
P.O. BOX 806, STATION B, 222 SOMERSET
STREET WEST, SUITE 600, OTTAWA,
ONTARIO, K2P2G3

TRADEMARK DETAILS

GIVLAARI

Trademark Type

Word

Goods

Class 05

Pharmaceutical preparations for the treatment of porphyria

Claims

Priority Filing Date: February 05, 2018, Country or Office: UNITED STATES OF AMERICA,
Application No: 87784738 in association with the same kind of goods

Application Number 1,881,989
Language of Application English

Filing Date 2018-02-07

APPLICANT DETAILS

Applicant
Pancherito
12 Avraham Stern
Tel Aviv 6608535
ISRAEL

TRADEMARK DETAILS

ISNUFF

Trademark Type
Word

Goods

Class 21

Jars; Cooking Utensils; Beverage Containers.

Application Number 1,882,463
Language of Application English

Filing Date 2018-02-09

APPLICANT AND AGENT DETAILS

Applicant

Chem Link, Inc.
353 E. Lyon Street
Schoolcraft, MI 49087
UNITED STATES OF AMERICA

Agent

GOWLING WLG (CANADA) LLP
SUITE 2600, 160 ELGIN STREET, OTTAWA,
ONTARIO, K1P1C3

TRADEMARK DETAILS

PRO PACK

Trademark Type

Word

Goods

Class 17

Pourable adhesive sealant for sealing and waterproofing roofs, decks, walls, floors and ceilings.

Claims

Priority Filing Date: September 22, 2017, Country or Office: UNITED STATES OF AMERICA,
Application No: 87619056 in association with the same kind of goods

Application Number 1,882,476
Language of Application English

Filing Date 2018-02-09

APPLICANT AND AGENT DETAILS

Applicant

ABUS August Bremicker Söhne KG
Altenhofer Weg 25
58300 Wetter-Volmarstein
GERMANY

Agent

GOWLING WLG (CANADA) LLP
SUITE 2600, 160 ELGIN STREET, OTTAWA,
ONTARIO, K1P1C3

TRADEMARK DETAILS

CombiFlex

Trademark Type

Word

Goods

Class 06

(1) Goods of metal, namely, padlocks, folding locks, u-locks, lock cylinders, closing hasps, door chains, shutter locks and grating locks, keys and key blanks, non-electrical wire rope, non-electrical metal cable wire.

(2) Goods of metal, namely, bicycle locks, cable padlocks; Locks of metal for containers for storage of goods, namely for freight, sea, storage and construction containers, outboard motor locks, Locks of metal for securing bicycle helmets, luggage, sporting equipment, pushchairs and garden furniture.

Class 12

(3) Parts and accessories for two-wheeled vehicles, namely, anti-theft devices for bicycles and motorcycles, parts and accessories for apparatus for locomotion by land and by water, namely electronic anti-theft devices for motor vehicles and boats and parts therefor.

(4) Anti-theft devices for bicycles; parts and accessories for apparatus for locomotion by land and water, namely, mechanical anti-theft devices for motor vehicles and boats and parts therefor.

Claims

Priority Filing Date: August 09, 2017, Country or Office: EUIPO (EU), Application No: 017091331 in association with the same kind of goods

Application Number 1,882,777
Language of Application English

Filing Date 2018-02-12

APPLICANT DETAILS

Applicant

KEITH ROSE
427 Braemar Crt
Saskatoon
SASKATCHEWAN S7V 1A2

TRADEMARK DETAILS

RUSTY NUTZ GARAGE

Trademark Type

Word

Goods

Class 08

(1) Mechanics' tools.

Class 09

(2) Automotive batteries and battery chargers.

Class 11

(3) Headlights and tail lights for vehicles; Vehicle brake lights and parking lights; Decorative ground effect and interior lights for automobiles.

Class 12

(4) Motor cars; Motor vehicle engines; Structural parts for automobiles; Tires for four-wheeled and two-wheeled motor vehicles; Windows for vehicles.

Class 21

(5) Sport water bottles; Cups and mugs.

Class 25

(6) Coveralls; Casual and athletic clothing; Hats.

Services

Class 35

(1) Sale of motor vehicles.

Class 37

(2) Maintenance and repair of motor vehicles; Installation of automobile parts.

Application Number 1,883,102
Language of Application English

Filing Date 2018-02-14

APPLICANT AND AGENT DETAILS

Applicant

Kinetic Orthotics Pty Ltd
12 Cessna St
Marcoola, QLD 4564
AUSTRALIA

Agent

CLAUDETTE DAGENAIS
(DJB), 500 Boulevard Gouin E, Suite 302,
Montréal, QUEBEC, H3L3R9

TRADEMARK DETAILS

SENSOKINETIC

Trademark Type

Word

Goods

Class 10

(1) Orthotic devices, namely, braces, splints, casts and straps; orthotic insoles; arch supports (orthopaedic), namely, arch supports for footwear and arch supports for shoes; inserts for orthopaedic footwear; insoles for orthopaedic footwear; orthopaedic footwear; orthopaedic inserts for footwear.

Class 25

(2) Footwear, namely, shoes, boots, slippers and sandals; footwear parts, namely, shoe uppers, heels, outsoles, innersoles, insoles, parts for shoe bottoms, namely soles of shoes.

Services

Class 44

Fitting of orthotic devices; fitting of orthopaedic devices; podiatry.

Application Number 1,883,336
Language of Application English

Filing Date 2018-02-15

APPLICANT AND AGENT DETAILS

Applicant

Horentek S.r.l.
Via Provinciale Francesca Sud, 141-
56029
Santa Croce sull'Arno (PI)
ITALY

Agent

SMART & BIGGAR LLP
SUITE 900, 55 METCALFE STREET, P.O.
BOX 2999, STATION D, OTTAWA, ONTARIO,
K1P5Y6

TRADEMARK DETAILS

Trademark Type

Design

Visual Representation

The logo for HORENTEK features a stylized 'H' symbol on the left, composed of three horizontal bars with a central gap, followed by the word 'HORENTEK' in a bold, uppercase, sans-serif font.

Goods

Class 09

(1) Software for remote medical diagnostics in the field of hearing disorders; medical software for measuring hearing; medical computer software, namely, software for interpreting hearing test results; instruments of amplification, namely, hearing aids and related accessories, namely, hearing aid batteries; electromagnetic measuring detectors; acoustic meters; wireless transmitter receivers, namely, radio transmitters and receivers; cords and connecting cables between audio receivers and audio amplifiers; public address speaker systems; mains feed-in apparatus; battery adapters; apparatus producing oscillations, namely, oscillators; induction devices, namely, induction voltage regulators to be coupled to telephones and to any sound emitting apparatus, namely, headphones, headsets, audio speakers; optical measuring components, namely, optical sensors, electromagnetic measuring detectors.

Class 10

(2) Diagnostic, examination, measuring and monitoring equipment in the field of hearing disorders; Audiometers; Artificial limbs; Aural prostheses, namely, auditory prostheses, cochlear implants; Implanted prosthesis, namely, auditory prostheses; Hearing aids for the deaf; Biodegradable prostheses, namely, auditory prostheses; Prosthetics and artificial implants, namely, cochlear implants made from artificial materials; Surgical instruments; Medical and surgical laparoscopes; Hearing aids; Medical hearing instruments; Apparatus for use in alleviating hearing disorders, namely, hearing aids, medical hearing instruments; Hearing protection devices, namely, hearing protection headsets, earplugs; Apparatus for use in treating hearing disorders, namely, hearing aids, medical hearing instruments; Acoustic apparatus for the hard of hearing, namely, hearing aids, medical hearing instruments; Digital hearing aids; Analog hearing aids; Electronic hearing aids; Ear trumpets; Curved pieces for bone-conduction receivers; Acoustic amplifiers [hearing aids] for partially deaf persons; Ear adaptors for hearing aids; Hearing aids for the deaf [acoustic aids]; Instruments for the examination of the troubles of the hearing, namely, medical hearing instruments and parts of such devices; receivers by air, namely instrument for transducing

electrical energy into mechanical energy (sound waves); receivers by bone, namely instrument for transducing electrical energy into mechanical energy (vibrations).

Services

Class 42

Development of diagnostic apparatus in the field of hearing disorders; Computer diagnostic services; Contriving designs services of measurement in the field of hearing disorders and in the audiological field to allow clinical diagnosis; Development of measuring and testing methods in the field of hearing disorders; Design of prostheses; Development of measuring probes for biotechnological applications; Development of prostheses; Advisory services relating to science in the audiological field; scientific research services; Medical research in the audiological field; Software development for audiometric and acoustic devices and for diagnostic apparatus in the field of hearing disorders.

Claims

Priority Filing Date: December 28, 2017, Country or Office: ITALY, Application No: 302017000150686 in association with the same kind of goods and in association with the same kind of services

Application Number 1,884,336
Language of Application French

Filing Date 2018-02-21

APPLICANT AND AGENT DETAILS

Applicant

Adfast Canada inc.
2685 rue Diab
Saint-Laurent
QUÉBEC H4S 1E7

Agent

AVENTUM IP LAW LLP
SUITE 830, TOWER B, , 555 LEGGET DRIVE,
OTTAWA, ONTARIO, K2K2X3

TRADEMARK DETAILS

ADSPUR

Trademark Type

Standard Characters

Goods

Class 17

Mastics de polyuréthane.

Application Number 1,884,466
Language of Application English

Filing Date 2018-02-22

APPLICANT AND AGENT DETAILS

Applicant

LOBLAWS INC.
1 Presidents Choice Circle
Brampton
ONTARIO L6Y 5S5

Agent

TORYS LLP
SUITE 3000, 79 WELLINGTON ST. W., BOX
270, TD CENTRE, TORONTO, ONTARIO,
M5K1N2

TRADEMARK DETAILS

HARVEST PEAK

Trademark Type

Standard Characters

Goods

Class 29

Avocado oil and avocado oil spray for food.

Application Number 1,884,559
Language of Application English

Filing Date 2018-02-22

APPLICANT AND AGENT DETAILS

Applicant

Société des Produits Nestlé S.A.
Case Postale 353
1800 Vevey
SWITZERLAND

Agent

BORDEN LADNER GERVAIS LLP
World Exchange Plaza, 100 Queen Street,
Suite 1300, Ottawa, ONTARIO, K1P1J9

TRADEMARK DETAILS

YOCUTA

Trademark Type

Standard Characters

Services

Class 41

Training, namely, conducting classes, seminars and workshops in the fields of nutrition and food, namely, food technology, nutrition, cooking and catering; organization of cultural and educational courses, seminars, conferences and exhibitions in the fields of nutrition and food, namely, food technology, nutrition, cooking and catering; online services, namely, training, namely, conducting classes, seminars and workshops in the fields of nutrition and food, namely, food technology, nutrition, cooking and catering; Online services, namely, organization of online cultural and educational courses, seminars, conferences and exhibitions in the fields of nutrition and food, namely, food technology, nutrition, cooking and catering; publishing of on-line electronic publications, editing and publication of books, pamphlets, newspapers, films and sound recordings, namely, music, podcasts, interviews and audio programming in the fields of nutrition and food, namely, food technology, nutrition, cooking and catering; production of videos and sound recordings, namely, music, podcasts, interviews and cooking instructions for cultural and educational purposes in the fields of nutrition and food, namely, food technology, nutrition, cooking and catering; education regarding nutrition, consisting of training and educational services in connection with nutrition and food, namely, training courses relating to food technology, nutrition, cooking and catering.

Application Number 1,884,577
Language of Application English

Filing Date 2018-02-22

APPLICANT AND AGENT DETAILS

Applicant

Zoetica Wildlife Research Service Inc.
102-22351 St Anne Ave
Maple Ridge
BRITISH COLUMBIA V2X 2E7

Agent

WITMART INC.
34 King Street East, Suite 500, Toronto,
ONTARIO, M5C2X8

TRADEMARK DETAILS

ZOETICA

Trademark Type

Word

Services

Class 42

Consulting services in the field of environmental assessment, namely, conservation planning, by way of analysis of environmental impacts caused by human land use and development, infrastructure, climate change, energy and mining developments and climate change planning, by way of the analysis of environmental impacts of environmental change in the disciplines of wildlife, vegetation, soils, water quality and availability, fish, environmental risk, and land use.

Application Number 1,884,625
Language of Application English

Filing Date 2018-02-23

APPLICANT AND AGENT DETAILS

Applicant
THE BELGIAN CHOCOLATE GROUP NV
Geelseweg 72
2250 Olen
BELGIUM

Agent
ROBIC
630, boul. René-Lévesque Ouest, 20e étage,
Montréal, QUEBEC, H3B1S6

TRADEMARK DETAILS

Trademark Type
Design

Visual Representation



for every mood and every occasion...

Goods

Class 30

Chocolate and chocolate products, namely, pralines, bonbons, chocolates in the shape of seafood, chocolate truffles; cookies, biscuits, chocolate sweets, chocolate confectionery; individually packaged chocolate sweets; pastries and sugar confectionery; flans; cakes.

Services

Class 35

(1) Advertisement, namely, distribution of advertising materials for others, distribution of promotional items, advertising messages and promotional materials, namely, distribution of samples for publicity purposes, distribution of products for others for advertising purposes, providing trade information in the field of marketing of chocolate and chocolate products, promoting the sale of goods and services through promotional contests and the distribution of related printed material, marketing, research and analysis, namely, collection of market research information, computerised market research services, market assessment services, market analysis and research, business organization and business economics advice, public relations, business administration, administrative services namely business administration assistance, business mediation in the wholesale trade in chocolate, chocolate products, biscuits, sweets, pastries and confectionery, retail services in chocolate, chocolate products, namely, biscuits, chocolate sweets, chocolate pastries and chocolate confectionery, commercial business management, data management, namely, business management services relating to information and data compiling

and analyzing, updating and maintenance of data in computer databases, data processing namely, administrative processing of purchase orders, database marketing services in the form of compiling customer specific databases, the aforesaid services also provided online.

Class 43

(2) Catering services; restaurant services (providing food and beverages); services offered by tearooms, snack bars, sandwich bars, canteens, self-service restaurants, fast food restaurants, drive-in restaurants, bars and cafes; food takeaway services.

Application Number 1,884,651
Language of Application English

Filing Date 2018-02-23

APPLICANT AND AGENT DETAILS

Applicant

TENOVA S.P.A.
Via Monte Rosa 93
Milano 20149
ITALY

Agent

NORTON ROSE FULBRIGHT CANADA LLP/S.
E.N.C.R.L.,S.R.L.
1, Place Ville Marie, Suite 2500, Montreal,
QUEBEC, H3B1R1

TRADEMARK DETAILS

CONSTEERRER

Trademark Type

Standard Characters

Goods

Class 07

(1) Installations, equipment and machinery for the metallurgy industry, namely, exhaust ducts as structural parts for iron and steel milling machines, conveyors for feeding industrial melting furnaces for use in iron and steel mills, and conveyors for use in liquid metal mills; metalworking machine tools, namely, stirrers being parts of metal smelting installations for molten metals and for metal alloy.

Class 11

(2) Furnaces for the production of molten metals; motor driven tools, namely stirrers specially adapted for metallurgical furnaces.

Services

Class 37

(1) Installation, maintenance and repair of metalworking machinery for the metallurgical industry.

Class 42

(2) Technical project design services of plants for the treatment of metals.

Application Number 1,885,084
Language of Application English

Filing Date 2018-02-26

APPLICANT AND AGENT DETAILS

Applicant

Google LLC
1600 Amphitheatre Parkway
Mountain View, CA 94043
UNITED STATES OF AMERICA

Agent

CLARK WILSON LLP
900 - 885 WEST GEORGIA STREET,
VANCOUVER, BRITISH COLUMBIA, V6C3H1

TRADEMARK DETAILS

Trademark Type

Design

Visual Representation



Colour Claim

Colour is claimed as a feature of the trade-mark. The colours red and white are claimed as a feature of the mark. The mark consists of a red gear wheel with a white triangle in the middle. The remaining white represents background and does not form part of the mark.

Goods

Class 09

Downloadable software that enables video creators to monitor and analyze video and channel performance, view, filter, and respond to video comments, receive notifications, update video details, and manage playlists

Claims

Priority Filing Date: August 28, 2017, Country or Office: UNITED STATES OF AMERICA, Application No: 87/586,356 in association with the same kind of goods

Application Number 1,886,917
Language of Application English

Filing Date 2018-03-08

APPLICANT AND AGENT DETAILS

Applicant

Siteimprove A/S
Sankt Annæ Plads 28
DK-1250
Copenhagen
DENMARK

Agent

GOWLING WLG (CANADA) LLP
SUITE 2600, 160 ELGIN STREET, OTTAWA,
ONTARIO, K1P1C3

TRADEMARK DETAILS

DCI

Trademark Type

Standard Characters

Goods

Class 09

Computer software in the field of website analytics, namely, computer software for analyzing, evaluating, scoring, tracking, and optimizing websites based on performance metrics; computer software in the field of website performance evaluation, namely, computer software for evaluating website performance based on, at least, accessibility, quality, and search engine optimization; computer software in the field of website evaluation, namely, computer software for generating website quality scores; computer software in the field of website evaluation, namely, computer software for generating website accessibility scores; computer software in the field of website evaluation, namely, computer software for generating website search engine optimization scores; computer software in the field of website evaluation, namely, computer software for generating a comprehensive website score combining multiple website scores accessing website performance across multiple performance metrics

Services

Class 35

(1) Providing business analysis and evaluation services relating to websites; business analytics, including, business evaluations, research, and information related to websites; business reports and management consultation; data marketing services, namely, providing statistical reports and marketing data evaluation for others by means of computer; providing ratings and rankings of other businesses' websites for commercial purposes based on performance metrics, including accessibility, quality, and visibility; providing information on the accessibility, usability, credibility and trustworthiness of the business websites of others; and business information services, namely, the collection, reporting, and analysis of business data, ratings, and rankings of other businesses' websites for commercial purposes based on performance metrics, including accessibility, quality, and visibility; website optimization services

Class 42

(2) Website services in the field of website analysis, namely, software as a service (SAAS) featuring software for analyzing, evaluating, scoring, tracking, and optimizing websites based on

performance metrics; website services in the field of website performance evaluation, namely, software as a service (SAAS) featuring software for evaluating website performance based on, at least, accessibility, quality, and search engine optimization; website services in the field of website evaluation, namely, software as a service (SAAS) featuring software for generating website quality scores; website services in the field of website evaluation, namely, software as a service (SAAS) featuring software for generating website accessibility scores; website services in the field of website evaluation, namely, software as a service (SAAS) featuring software for generating website search engine optimization scores; website services in the field of website evaluation, namely, software as a service (SAAS) featuring software for generating a comprehensive website score combining multiple website scores accessing website performance across multiple performance metrics; tracking and reporting of online website performance to determine the technological effectiveness of the website for non-business purposes; monitoring and reporting on the performance, availability, and errors of websites of others for scalability and quality control purposes

Claims

Priority Filing Date: October 02, 2017, Country or Office: UNITED STATES OF AMERICA, Application No: 87/629,902 in association with the same kind of goods and in association with the same kind of services

Application Number 1,886,919
Language of Application English

Filing Date 2018-03-08

APPLICANT AND AGENT DETAILS

Applicant

MACOLEX HOLDINGS INC./LES
PLACEMENTS MAC
OLEX INC.
10315 Chemin de la Côte-de-Liesse
Dorval
QUEBEC H9P 1A6

Agent

RICHARD UDITSKY
(ROBINSON SHEPPARD SHAPIRO S.E.N.C.
R.L./L.L.P.), 800 Place Victoria , Suite 4600 ,
Montreal, QUEBEC, H4Z1H6

TRADEMARK DETAILS

Trademark Type

Design

Visual Representation



Goods

Class 33

Dry wine

Application Number 1,886,920
Language of Application English

Filing Date 2018-03-08

APPLICANT AND AGENT DETAILS

Applicant

MACOLEX HOLDINGS INC./LES
PLACEMENTS MAC
OLEX INC.
10315 Chemin de la Côte-de-Liesse
Dorval
QUEBEC H9P 1A6

Agent

RICHARD UDITSKY
(ROBINSON SHEPPARD SHAPIRO S.E.N.C.
R.L./L.L.P.), 800 Place Victoria , Suite 4600 ,
Montreal, QUEBEC, H4Z1H6

TRADEMARK DETAILS

Trademark Type

Design

Visual Representation



Goods

Class 33

Late harvest wine

Application Number 1,886,922
Language of Application English

Filing Date 2018-03-08

APPLICANT AND AGENT DETAILS

Applicant

MACOLEX HOLDINGS INC./LES
PLACEMENTS MAC
OLEX INC.
10315 Ch Côte-de-Liesse
Dorval
QUEBEC H9P 1A6

Agent

RICHARD UDITSKY
(ROBINSON SHEPPARD SHAPIRO S.E.N.C.
R.L./L.L.P.), 800 Place Victoria , Suite 4600 ,
Montreal, QUEBEC, H4Z1H6

TRADEMARK DETAILS

Trademark Type

Design

Visual Representation



Goods

Class 33

Ice wine

Application Number 1,886,926
Language of Application English

Filing Date 2018-03-08

APPLICANT AND AGENT DETAILS

Applicant

MACOLEX HOLDINGS INC./LES
PLACEMENTS MAC
OLEX INC.
10315 Ch Côte-de-Liesse
Dorval
QUEBEC H9P 1A6

Agent

RICHARD UDITSKY
(ROBINSON SHEPPARD SHAPIRO S.E.N.C.
R.L./L.L.P.), 800 Place Victoria , Suite 4600 ,
Montreal, QUEBEC, H4Z1H6

TRADEMARK DETAILS

Trademark Type

Design

Visual Representation



Goods

Class 33

Cider

Application Number 1,886,942
Language of Application English

Filing Date 2018-03-08

APPLICANT AND AGENT DETAILS

Applicant

Republic Floor LLC
2250 Yates Ave.
Commerce, CA 90040
UNITED STATES OF AMERICA

Agent

BERESKIN & PARR LLP/S.E.N.C.R.L., S.R.L.
SCOTIA PLAZA, 40 KING STREET WEST,
40th FLOOR, TORONTO, ONTARIO, M5H3Y2

TRADEMARK DETAILS

MÜLLER GRAFF 1908

Trademark Type

Word

Goods

Class 19

Mouldings, not of metal, for cornices, namely wood mouldings, polyurethane mouldings; wood and polyurethane architectural mouldings and finish trim; wood and polyurethane decorative moldings and decorative trim for use in building construction; Underlay for laminate flooring; hardwood flooring, laminate flooring, vinyl flooring.

Application Number 1,887,209
Language of Application English

Filing Date 2018-03-09

APPLICANT AND AGENT DETAILS

Applicant

Galaxy Distribution Inc., a legal entity
7 High Forest Court
Caledon
ONTARIO L7E 0B8

Agent

RICHERS, MCKENZIE & HERBERT LLP
SUITE 1800, 2 BLOOR STREET EAST,
TORONTO, ONTARIO, M4W3J5

TRADEMARK DETAILS

JACK AND JILL OF ALL TIRES

Trademark Type

Word

Goods

Class 12

trolley for assisting in changing vehicle tires

Application Number 1,887,344
Language of Application English

Filing Date 2018-03-09

APPLICANT DETAILS

Applicant

ELIZABETH JADOO

43 Destiny Lane

Quispamsis

NEW BRUNSWICK E2E 0J9

TRADEMARK DETAILS

LIZZIE'S TRINI KITCHEN - NOW WE COOKIN'

Trademark Type

Word

Services

Class 41

(1) Cooking classes

Class 43

(2) Food and beverage catering; Mobile kitchen and food truck

Application Number 1,887,950
Language of Application English

Filing Date 2018-03-14

APPLICANT AND AGENT DETAILS

Applicant

Bioquell UK Limited, a legal entity
52 Royce Close
West Portway
Andover
Hampshire SP10 3TS
UNITED KINGDOM

Agent

RICHES, MCKENZIE & HERBERT LLP
SUITE 1800, 2 BLOOR STREET EAST,
TORONTO, ONTARIO, M4W3J5

TRADEMARK DETAILS

Bioquell ProteQ

Trademark Type

Word

Goods

Class 11

sterilisation, disinfection and decontamination equipment, namely, biodecontamination vapour generators and filters for use in units for sterilisation, decontamination and microbiological control in enclosures and buildings; gas generators; portable commercial and medical room sterilization machine for the sterilization of walls, floors, ceilings, worktops, and any equipment and fittings contained within the room by distributing hydrogen peroxide vapour into the air in cyclical intervals; air filtration installations, namely, gas generators for the production of biodecontamination vapour; ventilation and air filtering equipment and installations for purifying and sterilising air; installations and apparatus for air purification and sterilisation namely, hydrogen peroxide vapour generators for disinfection and chemical decontamination purposes; installations and apparatus for surface decontamination, namely, hydrogen peroxide vapour generators for disinfection and chemical decontamination purposes; surface sterilisation installations and systems, namely, hydrogen peroxide vapour generators for disinfection and chemical decontamination purposes; surface sterilisation units and air conditioning units, namely, hydrogen peroxide vapour generators for disinfection and chemical decontamination purposes; air sterilisation and conditioning units namely, hydrogen peroxide vapour generators, air filtration units and bio decontamination vapour generators for producing and maintaining an aseptic enclosure environment; contamination control equipment, namely, hydrogen peroxide vapour generators, air filtration units and bio decontamination vapour generators for producing and maintaining an aseptic enclosure environment; contamination control equipment, namely, HEPA filters for use in laminar and non-laminar filtration units for sterilisation, decontamination and microbiological control in hospitals and medical laboratories; parts and fittings for hydrogen peroxide vapour generators, biodecontamination vapour generators and air filtration units

Claims

Priority Filing Date: December 20, 2017, Country or Office: UNITED KINGDOM, Application No: 3278510 in association with the same kind of goods

Application Number 1,888,280
Language of Application English

Filing Date 2018-03-15

APPLICANT AND AGENT DETAILS

Applicant

E. REMY MARTIN & C°
20 rue de la Société Vinicole
16100
Cognac
FRANCE

Agent

SMART & BIGGAR IP AGENCY CO.
1100-150 York street, TORONTO, ONTARIO,
M5H3S5

TRADEMARK DETAILS

Trademark Types

Design
Position

Visual Representation



Trademark Description

The trademark consists of the position of an oval medallion and a label applied to a three-dimensional bottle, as shown in the visual representation. The medallion contains a depiction of a lion in the center and a surrounding oval outline. The label contains the word ST-RÉMY with a horizontal line below it. Below the horizontal line are, from top to bottom, the words EXTRA OLD, XO, and FRENCH BRANDY FRANÇAIS. There is an image of a lion beneath the letters XO and 3 fleur de lis images at the bottom of the label. The three-dimensional bottle shown in dotted outline in the drawing does not form part of the trademark and is shown merely to provide an example of how the trademark may be applied to a three-dimensional object.

Colour Claim

Colour is claimed as a feature of the trademark. The depiction of the lion in the center of the bottle and the surrounding oval outline are gold. The label below the medallion contains word ST-RÉMY is gold. The line below the word ST-RÉMY is gold. The words EXTRA OLD and FRENCH

BRANDY FRANÇAIS are silver. The letters X and O are red. The image of the lion underneath the letters XO is silver. The fleur de lis images at the bottom of the label are, from left to right, blue, white, and red.

Exclusion from trademark
test

Goods

Class 33

Brandy.

Claims

Priority Filing Date: December 01, 2017, Country or Office: FRANCE, Application No: 4409571 in association with the same kind of goods

Application Number 1,888,356
Language of Application English

Filing Date 2018-03-15

APPLICANT AND AGENT DETAILS

Applicant

Del Taco LLC (a Limited Liability
Company of the State of California)
25521 Commercentre Drive
Lake Forest, CA 92630
UNITED STATES OF AMERICA

Agent

METHOD LAW PROFESSIONAL
CORPORATION
4211 Yonge Street, Suite 310, Toronto,
ONTARIO, M2P2A9

TRADEMARK DETAILS

Trademark Type

Design

Visual Representation



Foreign Character Translation

The translation provided by the applicant of the Spanish word(s) DEL TACO is OF THE TACO.

Services

Class 43

Restaurant services

Application Number 1,888,493
Language of Application English

Filing Date 2018-03-16

APPLICANT AND AGENT DETAILS

Applicant

E. REMY MARTIN & C^o
20, rue de la Société Vinicole
16100 Cognac
FRANCE

Agent

SMART & BIGGAR IP AGENCY CO.
1100-150 York street, TORONTO, ONTARIO,
M5H3S5

TRADEMARK DETAILS

Trademark Types

Design
Position

Visual Representation



Trademark Description

The trademark consists of the position of an oval medallion and a label applied to a three-dimensional bottle, as shown in the visual representation. The medallion contains a depiction of a lion in the center and a surrounding oval outline. The label contains the word ST-RÉMY with a horizontal line below it. Below the horizontal line are, from top to bottom, the words VSOP and FRENCH BRANDY FRANÇAIS. There is an image of a lion beneath the letters VSOP and 3 fleur de lis images at the bottom of the label. The three-dimensional bottle shown in dotted outline in the drawing does not form part of the trademark and is shown merely to provide an example of how the trademark may be applied to a three-dimensional object.

Colour Claim

Colour is claimed as a feature of the trademark. The depiction of the lion in the center of the bottle and the surrounding oval outline are gold. The label below the medallion contains the word ST-RÉMY in gold. The line below the word ST-RÉMY is gold. The word VSOP is black and the words FRENCH BRANDY FRANÇAIS are red. The image of the lion underneath the letters VSOP is gold. The fleur de lis images at the bottom of the label are, from left to right, blue, white, and red.

Goods

Class 33

Brandy.

Claims

Priority Filing Date: December 01, 2017, Country or Office: FRANCE, Application No: 4409550 in association with the same kind of goods

Application Number 1,888,814
Language of Application English

Filing Date 2018-03-19

APPLICANT AND AGENT DETAILS

Applicant

M.A. Mortenson Company
700 Meadow Lane North
Minneapolis, MN 55422
UNITED STATES OF AMERICA

Agent

BERESKIN & PARR LLP/S.E.N.C.R.L., S.R.L.
SCOTIA PLAZA, 40 KING STREET WEST,
40th FLOOR, TORONTO, ONTARIO, M5H3Y2

TRADEMARK DETAILS

BLU54

Trademark Type

Word

Services

Class 35

(1) Distributorship services in the field of building construction materials and electrical supplies for construction projects; procurement, namely, purchasing building construction materials and electrical supplies for others; transportation logistics services, namely, planning, scheduling, and arranging the transportation of goods for others; Inventory control management; Supply chain and freight logistics management services for others.

Class 39

(2) Supply chain logistics and reverse logistics services, namely, storage, transportation and delivery of goods for others by air, rail, ship or truck; Distribution services, namely, delivery of building construction materials and electrical supplies to general contractors and subcontractors.

Claims

Priority Filing Date: October 04, 2017, Country or Office: UNITED STATES OF AMERICA,
Application No: 87633376 in association with the same kind of services

Application Number 1,888,815
Language of Application English

Filing Date 2018-03-19

APPLICANT AND AGENT DETAILS

Applicant

M.A. Mortenson Company
700 Meadow Lane North
Minneapolis, MN 55422
UNITED STATES OF AMERICA

Agent

BERESKIN & PARR LLP/S.E.N.C.R.L., S.R.L.
SCOTIA PLAZA, 40 KING STREET WEST,
40th FLOOR, TORONTO, ONTARIO, M5H3Y2

TRADEMARK DETAILS

Trademark Type

Design

Visual Representation



Services

Class 35

(1) Distributorship services in the field of building construction materials and electrical supplies for construction projects; procurement, namely, purchasing building construction materials and electrical supplies for others; transportation logistics services, namely, planning, scheduling, and arranging the transportation of goods for others; Inventory control management; Supply chain and freight logistics management services for others.

Class 39

(2) Supply chain logistics and reverse logistics services, namely, storage, transportation and delivery of goods for others by air, rail, ship or truck; Distribution services, namely, delivery of building construction materials and electrical supplies to general contractors and subcontractors.

Claims

Priority Filing Date: October 04, 2017, Country or Office: UNITED STATES OF AMERICA,
Application No: 87633384 in association with the same kind of services

Application Number 1,889,091
Language of Application English

Filing Date 2018-03-20

APPLICANT AND AGENT DETAILS

Applicant

Hästens Sängar AB
P.O. Box 130
731 23 KÖPING
SWEDEN

Agent

SMART & BIGGAR LLP
1000 RUE DE LA GAUCHETIERE OUEST,
BUREAU 3300, MONTREAL, QUEBEC,
H3B4W5

TRADEMARK DETAILS

EALA

Trademark Type

Word

Foreign Character Translation

The translation provided by the applicant of the Hawaiianska word(s) Eala is 'arise, awake, get up'.

Goods

Class 20

(1) Furniture and furnishings, namely, bedroom furniture, beds, bed frames, bedsteads, mattresses, spring mattresses, overlay mattresses, mattress toppers, pillows, down pillows and cushions

Class 24

(2) Textile goods and substitutes for textile goods, namely, bed linen, bed throws, bed spreads, duvets, duvet covers, comforters, sleeping bag liners, pillowcases, mattress covers, bed valances, bed skirts, bed canopies, bedroom curtains, plaided blankets, quilts, blankets, throws, down quilts, towels, namely, bath towels, cloth towels, face towels, cotton towels, hand towels

Claims

Priority Filing Date: March 02, 2018, Country or Office: SWEDEN, Application No: 017867587 in association with the same kind of goods

Application Number 1,889,092
Language of Application English

Filing Date 2018-03-20

APPLICANT AND AGENT DETAILS

Applicant

Hästens Sängar AB
P.O. Box 130
731 23 KÖPING
SWEDEN

Agent

SMART & BIGGAR LLP
1000 RUE DE LA GAUCHETIERE OUEST,
BUREAU 3300, MONTREAL, QUEBEC,
H3B4W5

TRADEMARK DETAILS

HERLEWING

Trademark Type

Word

Foreign Character Translation

The translation provided by the applicant of the Afrikaans word(s) Herlewing is 'awakening, revival'.

Goods

Class 20

(1) Furniture and furnishings, namely, bedroom furniture, beds, bed frames, bedsteads, mattresses, spring mattresses, overlay mattresses, mattress toppers, pillows, down pillows and cushions

Class 24

(2) Textile goods and substitutes for textile goods, namely, bed linen, bed throws, bed spreads, duvets, duvet covers, comforters, sleeping bag liners, pillowcases, mattress covers, bed valances, bed skirts, bed canopies, bedroom curtains, plaided blankets, quilts, blankets, throws, down quilts, towels, namely, bath towels, cloth towels, face towels, cotton towels, hand towels

Claims

Priority Filing Date: March 02, 2018, Country or Office: SWEDEN, Application No: 017867588 in association with the same kind of goods

Application Number 1,889,167
Language of Application English

Filing Date 2018-03-20

APPLICANT AND AGENT DETAILS

Applicant

Pfizer Inc
235 East 42nd Street
New York, NY 10017
UNITED STATES OF AMERICA

Agent

BERESKIN & PARR LLP/S.E.N.C.R.L., S.R.L.
SCOTIA PLAZA, 40 KING STREET WEST,
40th FLOOR, TORONTO, ONTARIO, M5H3Y2

TRADEMARK DETAILS

DACERZ

Trademark Type

Standard Characters

Goods

Class 05

pharmaceutical preparations for the treatment of psychiatric diseases and brain disorders, namely, mood, anxiety and cognitive disorders, Alzheimer's, cerebral palsy, Parkinson's disease, Huntington's disease, growth and thyroid disorders, seizures, central nervous system, namely brain, movement, ocular motility and spinal cord infections, injuries and diseases, neuromuscular and neurodegenerative nerve diseases and disorders, namely multiple sclerosis, amyotrophic lateral sclerosis (ALS), Parkinson's disease, Alzheimer's disease, Huntington's disease, epilepsy, cerebral palsy, brain injury, spinal cord injury, seizure disorders, dementia, cranial and facial nerve disorders, tissue injuries, and bone and cartilage injuries, diseases and disorders, namely inflammatory connective tissue diseases and disorders and inflammatory muscle diseases and disorders, fractures, sprains, cartilage injuries, dislocated joints and muscle soreness, muscle spasms and muscle tremors, pelvic, urological and reproductive system diseases and disorders, namely infections, sexually transmitted diseases, erectile and sexual dysfunction, infertility and incontinence, auto-immune, cardiovascular, gastrointestinal, hematologic, oncological, ophthalmological and respiratory system diseases and disorders, pharmaceutical preparations for the relief of allergies, hypertension, menopause and pain, antibiotics and anti-infectives, anti-inflammatories, anti-fungals, anti-virals, oral and injectable contraceptives, human vaccines and smoking cessation medications

Application Number 1,889,406
Language of Application English

Filing Date 2018-03-21

APPLICANT DETAILS

Applicant

Fundopolis LLC
Two Oliver Street, 10th Floor
Boston, MA 02109
UNITED STATES OF AMERICA

TRADEMARK DETAILS

Trademark Type

Design

Visual Representation



Colour Claim

Colour is claimed as a feature of the trade-mark. The color(s) dark green, grey-green and aquamarine is/are claimed as a feature of the mark. The mark consists of a diamond with a dark green and aquamarine border having two grey-green interior parallel lines.

Services

Class 36

(1) Crowdfunding services in the nature of providing financing of loans and venture capital financing from money collected from individuals or groups; monetary exchange operations; securities brokerage; financial services, namely, assisting others with the completion of financial transactions for securities; financial investment services, namely, administering the issuance, underwriting and distribution of securities; financial planning and investment advisory services; securities trading.

Class 45

(2) Online social networking services

Claims

Priority Filing Date: October 05, 2017, Country or Office: UNITED STATES OF AMERICA,
Application No: 87/635121 in association with the same kind of services

Application Number 1,890,319
Language of Application English

Filing Date 2018-03-22

APPLICANT AND AGENT DETAILS

Applicant

Wong To Yick Wood Lock Ointment Limited
4/F, Mai Shun Industrial Building
18-24 Kwai Cheong Road
Kwai Chung, New Territories
HONG KONG

Agent

ANDREA FRIEDMAN-RUSH
(BLANEY MCMURTRY LLP), 2 Queen Street
East, Suite 1500, Toronto, ONTARIO, M5C3G5

TRADEMARK DETAILS

Trademark Type

Design

Visual Representation



Foreign Character Translation

The translation provided by the applicant of the Chinese word(s) Wong To Yick is yellow, road, advantage.

Foreign Character Transliteration

The transliteration provided by the applicant of the Chinese character(s) is Wong To Yick.

Goods

Class 05

Medicated balms for treatment of skin, namely topical analgesic medication; medicated skin balm, oils and creams for use on the skin for the analgesic treatment of muscle and joint pains, including arthritis, backaches, bruises, sprains and strains

Application Number 1,890,320
Language of Application English

Filing Date 2018-03-22

APPLICANT AND AGENT DETAILS

Applicant

Wong To Yick Wood Lock Ointment Limited
4/F, Mai Shun Industrial Building
18-24 Kwai Cheong Road
Kwai Chung, New Territories
HONG KONG

Agent

ANDREA FRIEDMAN-RUSH
(BLANEY MCMURTRY LLP), 2 Queen Street
East, Suite 1500, Toronto, ONTARIO, M5C3G5

TRADEMARK DETAILS

Trademark Type

Design

Visual Representation

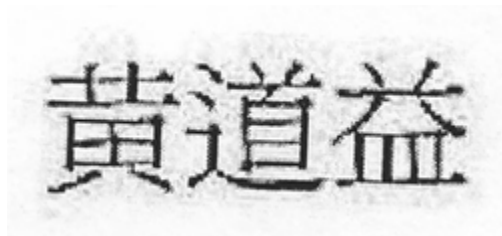

Foreign Character Translation

The translation provided by the applicant of the Chinese word(s) Wong To Yick is yellow, road, advantage.

Foreign Character Transliteration

The transliteration provided by the applicant of the Chinese character(s) is Wong To Yick.

Goods

Class 05

Medicated balms for treatment of skin, namely topical analgesic medication; medicated skin balm, oils and creams for use on the skin for the analgesic treatment of muscle and joint pains, including arthritis, backaches, bruises, sprains and strains

Application Number 1,890,371
Language of Application English

Filing Date 2018-03-27

APPLICANT AND AGENT DETAILS

Applicant

TREND MICRO KABUSHIKI KAISHA, a
Japanese
Corporation
Shinjuku Maynds Tower
2-1-1 Yoyogi, Shibuya-ku
Tokyo 151-0053
JAPAN

Agent

GOWLING WLG (CANADA) LLP
550 BARRARD STREET, SUITE 2300,
VANCOUVER, BRITISH COLUMBIA, V6C2B5

TRADEMARK DETAILS

DEEP SECURITY

Trademark Type

Standard Characters

Goods

Class 09

Computer software, namely, cyber security software; computer software for computer security, computer network security, information security, and firewall security purposes; computer software in the field of the security risk industry, namely, computer security software; computer software for managing computer security strategy and resources; computer software for managing server, virtual server, virtual desktop, and cloud security

Services

Class 41

(1) product training, namely, training in the use and operation of software and computer hardware used for the purpose of cyber security, computer security, network security, and electronic data security; software security training, namely, training others in maintaining software security in the field of cyber threats; training services in the field of information security compliance, information risk management, and computer network security; educational services, namely conducting courses, workshops, and seminars in the fields of cyber security, computer security, data security, information security, application security, and network security

Class 42

(2) Providing online non-downloadable software in the field of computer security; Software as a Service (SAAS) services featuring computer security and risk assessment; computer software consulting; software design and development services; custom design and configuration of computer networks for third parties; Computer programming services

Application Number 1,890,551
Language of Application English

Filing Date 2018-03-27

APPLICANT AND AGENT DETAILS

Applicant

Sandouchon Holding Inc.
9245, rue Thimens
Pierrefonds
QUEBEC H8Y 0A1

Agent

DS AVOCATS CANADA, S.E.N.C.R.L. / DS
LAWYERS CANADA, LLP,
Attn: Me Nathaly J. Vermette, 1080 Beaver
Hall Hill, Suite 2100, Montréal, QUEBEC,
H2Z1S8

TRADEMARK DETAILS

SANDOUCHON

Trademark Type

Standard Characters

Goods

Class 30

Sandwiches.

Services

Class 35

(1) Business management advisory services relating to franchising of food outlets and home delivery services; Offering technical assistance in the establishment and operation of restaurant franchises of food outlets and home delivery services.

Class 43

(2) Restaurant services; take-out restaurant services.

Class 45

(3) Awarding of licenses for franchising of food outlets and home delivery services.

Application Number 1,891,001
Language of Application English

Filing Date 2018-03-29

APPLICANT AND AGENT DETAILS

Applicant

HeadStart Medical Ltd.
2502 - 9603 Manchester Dr.
Burnaby
BRITISH COLUMBIA V3N 4Y7

Agent

DEETH WILLIAMS WALL LLP
150 YORK STREET, SUITE 400, TORONTO,
ONTARIO, M5H3S5

TRADEMARK DETAILS

NAPKAP

Trademark Type

Standard Characters

Goods

Class 10

cranial remodelling orthosis

Application Number 1,891,544
Language of Application English

Filing Date 2018-04-03

APPLICANT AND AGENT DETAILS

Applicant

Sleeman Breweries Ltd.
551 Clair Road West
Guelph
ONTARIO N1L 0H7

Agent

GOWLING WLG (CANADA) LLP
SUITE 2600, 160 ELGIN STREET, OTTAWA,
ONTARIO, K1P1C3

TRADEMARK DETAILS

Saison des Artisans

Trademark Type

Word

Goods

Class 32

Beer

Application Number 1,891,756
Language of Application English

Filing Date 2018-04-04

APPLICANT AND AGENT DETAILS

Applicant

Toco Imports, LLC limited Liability
Company Texas
911 W. 38th Street
Suite 101
Austin, TX 78705
UNITED STATES OF AMERICA

Agent

SPIEGEL SOHMER, INC.
1255, Peel Street, Suite 1000, Montreal,
Attention: IP department, QUEBEC, H3B2T9

TRADEMARK DETAILS

TOCO

Trademark Type

Standard Characters

Goods

Class 33

Distilled spirits, namely rum and cachaça

Claims

Priority Filing Date: October 04, 2017, Country or Office: UNITED STATES OF AMERICA,
Application No: 87633881 in association with the same kind of goods

Application Number 1,892,027
Language of Application English

Filing Date 2018-04-05

APPLICANT AND AGENT DETAILS

Applicant

Umbra LLC
1705 Broadway Street
Buffalo, NY 14212
UNITED STATES OF AMERICA

Agent

RIDOUT & MAYBEE LLP
250 University Avenue, 5th Floor, Toronto,
ONTARIO, M5H3E5

TRADEMARK DETAILS

CASIUS

Trademark Type

Standard Characters

Goods

Class 20

Picture frames; wall shelving

Application Number 1,892,437
Language of Application English

Filing Date 2018-04-09

APPLICANT DETAILS

Applicant

Dongguan Group Sense Plastic Technology
Ltd.
Cai Wu Industrial Park,Wusha
Chang An Dongguan
Guangdong, 523871
CHINA

TRADEMARK DETAILS

Trademark Type

Design

Visual Representation



Goods

Class 11

air cleaning units; boilers for heating installations; electric appliances for making yogurt; electric coffee machines; electric heaters for babies bottles; electric kettles for household purposes; electric radiators; electromagnetic induction cookers for household purposes; hearths; luminaires; municipal water purification machines; refrigerators; ventilating fans; water sterilisers

Application Number 1,892,453
Language of Application English

Filing Date 2018-04-09

APPLICANT DETAILS

Applicant

Tracy Hanes Matthew Pierrynowski a joint
venture.
17244 Leslie St
Newmarket
ONTARIO L3Y 7C4

TRADEMARK DETAILS

Beachwood

Trademark Type

Word

Goods

Class 02

(1) coatings for wood as paints; coatings for wood in the nature of paints

Class 16

(2) patterns for making clothes; patterns for making clothing

Class 18

(3) bags for sports clothing; beach bags; beach umbrellas; clothing for animals; clothing for dogs; clothing for pets; dog clothing; pet clothing

Class 19

(4) balsa wood

Class 21

(5) beer glasses; cocktail glasses; drinking glasses

Class 24

(6) beach towels

Class 25

(7) athletic clothing; baby clothes; baby clothing; beach clothes; beach cover-ups; beach footwear; beach pyjamas; beach robes; beach shoes; beach wraps; belts; casual clothing; casual clothing featuring pants, dresses and shorts; children's clothing; clothing belts; infant clothing; outdoor winter clothing; sports clothing; sports footwear; sun protective clothing; wristbands [clothing]

Class 26

(8) arm bands [clothing accessories]; belt buckles for clothing; belt buckles of precious metal for clothing; bra pads for clothing; clothing patches; fastenings for clothing; ornamental patches for clothing; patches for clothing; patches for clothing made of vinyl; textile patches for clothing

Class 27

(9) beach mats

Services**Class 35**

(1) computerized online ordering featuring clothing; online sales of clothing; online sales of footwear; operation of a clothing store; retail clothing store services; retail sale of clothing; retail services provided by clothing boutiques; retail store services featuring clothing; sale of clothing; wholesale sales of clothing; wholesale store services featuring clothing

Class 40

(2) applying finishes to clothing; clothing alteration; custom clothing alteration; custom imprinting of clothing; waterproofing of footwear

Class 42

(3) design of clothing

Application Number 1,892,757
Language of Application English

Filing Date 2018-04-10

APPLICANT AND AGENT DETAILS

Applicant

The H.D. Lee Company, Inc.
3411 Silverside Road
Wilmington, DE 19810
UNITED STATES OF AMERICA

Agent

OSLER, HOSKIN & HARCOURT LLP
SUITE 1900, 340 ALBERT STREET,
OTTAWA, ONTARIO, K1R7Y6

TRADEMARK DETAILS

BOY PROOF

Trademark Type

Word

Goods

Class 25

Clothing, namely, shirts, t-shirts, blouses, sweaters, sweatshirts, jeans, casual pants, trousers, capris, shorts, skirts, dresses, coveralls, overalls, sweatpants, sweat shorts, vests, jackets, hooded jackets, coats, socks, hosiery, underwear, loungewear, sleepwear, bath robes, belts, suspenders, scarves, gloves and mittens; footwear, namely, shoes, boots, sandals, and slippers; headwear, namely, hats and caps.

Application Number 1,893,136
Language of Application English

Filing Date 2018-04-11

APPLICANT AND AGENT DETAILS

Applicant

Downhole Products Limited
Badentoy Road, Badentoy Park
Portlethen
AB12 4YA
Aberdeen, Scotland
UNITED KINGDOM

Agent

GOWLING WLG (CANADA) LLP
SUITE 2600, 160 ELGIN STREET, OTTAWA,
ONTARIO, K1P1C3

TRADEMARK DETAILS

LEDGERUNNER

Trademark Type

Word

Goods

Class 06

Metal casing accessories and components for use in oil and gas exploration, drilling of bore holes and production of oil and gas, namely, casing shoes, downhole subs and drill collars.

Application Number 1,893,469
Language of Application English

Filing Date 2018-04-12

APPLICANT AND AGENT DETAILS

Applicant

ZWFuture Education Inc.
A405-5151 Brighthouse Way
Richmond
BRITISH COLUMBIA V7C 0A6

Agent

SAMPSON PUN
(CNS Law Corporation), 5811 Cooney Road,
Suite 602 North Tower, Richmond, BRITISH
COLUMBIA, V6X3M1

TRADEMARK DETAILS

Trademark Type

Design

Visual Representation



Foreign Character Translation

The English translation of the four Chinese characters in the trademark is ZHUGE ACADEMY.

Foreign Character Transliteration

ZHU GE XUE TANG

Goods

Class 09

(1) digital books and magazines downloadable from the Internet; downloadable video and audio recordings which provide courses of instruction at the primary school, secondary school and college levels; audio books

Class 16

(2) books and magazines, textbooks, books containing instructions and materials for test preparation;

Services

Class 41

conducting courses of instruction at the primary school level, conducting courses of instruction at the secondary school level, conducting courses of instruction at the college level; conducting distance learning instruction at the primary school level, conducting distance learning instruction at the secondary school level, conducting distance learning instruction at the college level; providing educational courses in the fields of Chinese language studies, literature, poetry, essay writing, and technical writing; providing educational courses in the fields of art, history, music, math, sciences, computer science, vocational training, early childhood education, sports, fitness, cooking, baking, painting, graphic design, photography, dance, computer programming, website design, business administration and health care; operation of language schools; educational services in the field of language training; operation of language schools teaching English, French and Chinese

languages; provision of courses of instruction in languages; conducting courses of instruction for exam preparations at the primary school level, conducting courses of instruction for exam preparations at the secondary school level, conducting courses of instruction for exam preparations at the college level; arranging and conducting academic contests at the primary school level, arranging and conducting academic contests at the secondary school level, arranging and conducting academic contests at the college level; on-line electronic publishing of books and periodicals; publishing of books, textbooks and reviews; video production, production of educational videos; Providing courses of instruction at the primary school, secondary school and college levels in the form of videos and audio recordings via a website; providing after-school educational programs for students at the primary school and secondary school levels; providing after-school educational programs for students at the primary school and secondary school levels off campus and on campus; educational services, namely, providing tutoring at the primary school, secondary school and college levels; educational services, namely, teacher training in the fields of development and delivery of after-school curriculum and in-class and online teaching and tutoring methods

Application Number 1,894,421
Language of Application English

Filing Date 2018-04-18

APPLICANT AND AGENT DETAILS

Applicant

Orthogen AG
Ernst-Schneider-Platz 1
40212 Düsseldorf
GERMANY

Agent

BLAKE, CASSELS & GRAYDON LLP
INTELLECTUAL PROPERTY GROUP, SUITE
4000, COMMERCE COURT WEST, 199 BAY
STREET, TORONTO, ONTARIO, M5L1A9

TRADEMARK DETAILS

EXOKINE

Trademark Type

Word

Goods

Class 03

(1) Skin care products, namely, creams, lotions; dermatological preparations and substances for cosmetic purposes, namely serum; non-medicated cosmetics.

Class 05

(2) Medical therapeutic preparations and remedies, namely blood preparations and blood products, for treatment of joints, muscles, nerves, ligaments, cartilage and bones; dermatological preparations and substances for the treatment of (the signs of) aging, namely skin conditioning, improvement of elasticity, hydration and skin structure; medical preparations for treatment of the effects of dermatitis, eczema and psoriasis.

Class 10

(3) Instruments, devices and apparatus, namely syringes, blood bags, cannulas, for drawing, processing and storage of blood and blood preparations in the medical sector; medical instruments and apparatus and their blood collection systems, in particular comprising syringes, blood bags, cannulas; syringes, blood bags, cannulas for blood drawing.

Application Number 1,894,720
Language of Application English

Filing Date 2018-04-19

APPLICANT AND AGENT DETAILS

Applicant

Josef Kränzle GmbH & Co. KG
Rudolf-Diesel-Straße 20
89257 Illertissen
GERMANY

Agent

BENOÎT & CÔTÉ INC.
560 boul. Crémazie Est, 3e étage, Montréal,
QUEBEC, H2P1E8

TRADEMARK DETAILS

Trademark Type

Design

Visual Representation



Colour Claim

Colour is claimed as a feature of the trademark. The word 'kranzle' is blue. The horizontal bar and letter 'x' are red.

Goods

Class 07

Motor-operated high-pressure cleaning apparatus, namely, industrial floor cleaning machines, industrial vacuum cleaners; Motor pumps for high-pressure cleaning apparatus; Fittings for the aforesaid high-pressure cleaning apparatus namely, hoses and nozzles, and machine parts therefore namely, bearings and bearing housings.

Services

Class 35

Wholesale and retail services, including via the Internet and by mail order, in relation to motor-operated high-pressure cleaning apparatus, namely, industrial floor cleaning machines, industrial vacuum cleaners, motor pumps for high-pressure cleaning apparatus, fittings for the aforesaid high-pressure cleaning apparatus and accessory machine parts therefor

Application Number 1,895,356
Language of Application English

Filing Date 2018-04-24

APPLICANT AND AGENT DETAILS

Applicant

SNAILAX CORPORATION
1687 plymouth rd Unit C
Ann Arbor
Michigan, MI 48105
UNITED STATES OF AMERICA

Agent

MILTONS IP/P.I.
15 Fitzgerald Rd, Suite 200, Ottawa,
ONTARIO, K2H9G1

TRADEMARK DETAILS

Trademark Type

Design

Visual Representation



Goods

Class 10

(1) Air mattresses for medical purposes; Blankets, electric, for medical purposes; Gloves for massage; Heating cushions, electric, for medical purposes; Heating pads, electric, for medical purposes; Massage beds for medical purposes; Massage chairs; Medical products, namely, therapeutic mattresses, beds, seats and cushions; Soporific pillows for insomnia; facial massagers; gum massagers; massage mitts; vibrators massagers

Class 11

(2) Air humidifiers; Dehumidifiers for household purposes; Fireplaces, domestic; Blankets, electric; Footmuffs, electrically heated; Electrically heated carpets; Socks, electrically heated; Humidifiers for household purposes; Pocket warmers; USB powered hand warmers.

Application Number 1,895,359
Language of Application English

Filing Date 2018-04-24

APPLICANT AND AGENT DETAILS

Applicant

SNAILAX CORPORATION
1687 plymouth rd Unit C
Ann Arbor
Michigan, MI 48105
UNITED STATES OF AMERICA

Agent

MILTONS IP/P.I.
15 Fitzgerald Rd, Suite 200, Ottawa,
ONTARIO, K2H9G1

TRADEMARK DETAILS

SNAILAX

Trademark Type

Word

Goods

Class 10

(1) Air mattresses for medical purposes; Blankets, electric, for medical purposes; Gloves for massage; Heating cushions, electric, for medical purposes; Heating pads, electric, for medical purposes; Massage beds for medical purposes; Massage chairs; Medical products, namely, therapeutic mattresses, beds, seats and cushions; Soporific pillows for insomnia; facial massagers; gum massagers; massage mitts; vibrators massagers

Class 11

(2) Air humidifiers; Dehumidifiers for household purposes; Fireplaces, domestic; Blankets, electric; Footmuffs, electrically heated; Electrically heated carpets; Socks, electrically heated; Humidifiers for household purposes; Pocket warmers; USB powered hand warmers

Application Number 1,895,687
Language of Application English

Filing Date 2018-04-25

APPLICANT AND AGENT DETAILS

Applicant

GDK International Limited
110 Easter Queenslie Road
Glasgow G33 4UL
UNITED KINGDOM

Agent

KATE HENDERSON
128 Vine Avenue, Toronto, ONTARIO, M6P1V7

TRADEMARK DETAILS

GDK

Trademark Type

Word

Services

Class 43

Cafe services; fast-food restaurants; restaurant services; catering of food and drink; offsite services for providing food and drink; catering services; delicatessens [restaurants]; grill restaurants; self-service restaurants; carry-out restaurants; snackbars; salad bars; wine bars; wine bar services; restaurant services incorporating licensed bar facilities; provision of information relating to restaurants and bars services; consultancy services in relation to food and drink preparation, namely, consultancy services in the field of restaurant and bar services; rental of food service equipment, namely, rotisseries, electric hot plates, dishes and plates, cutlery and flatware, kitchen worktops.

Application Number 1,896,345
Language of Application English

Filing Date 2018-04-27

APPLICANT AND AGENT DETAILS

Applicant

WCC IP HOLDINGS, LLC
12362 Beach Blvd., Suite 26
Stanton, CA 90680
UNITED STATES OF AMERICA

Agent

SMART & BIGGAR LLP
2300 - 1055 West Georgia Street, P.O. Box
11115, Vancouver, BRITISH COLUMBIA,
V6E3P3

TRADEMARK DETAILS

CURE

Trademark Type

Word

Goods

Class 18

(2) Bags, namely, waist bags, shoulder bags, backpacks, duffel bags, travel bags, sports bags, suitcases, knapsacks, crossbody bags, handbags, all-purpose carrying bags, all-purpose reusable carrying bags and accessories thereof in the nature of leather straps, cloth straps for luggage and handbags, chain straps for handbags, rope straps for luggage and handbags, and fitted protective covers for travel bags, namely, waist bags, shoulder bags, backpacks, duffel bags, travel bags, sports bags, suitcases, knapsacks, crossbody bags, handbags, all-purpose carrying bags, and reusable carrying bags, and straps for carrying shopping bags made of paper and cloth.

Class 25

(1) Clothing, namely, t-shirts.

Application Number 1,896,357
Language of Application French

Filing Date 2018-04-30

APPLICANT DETAILS

Applicant

David Tremblay F.D.InnoVations inc.
938 rue Saint-Louis
Terrebonne
QUEBEC J6W 1K2

TRADEMARK DETAILS

Trademark Type

Design

Visual Representation



Colour Claim

Colour is claimed as a feature of the trademark. The term DzelCat is blue, the cat is black, and the background is white.

Goods

Class 21

Products for cats, namely a plastic mat for cats that goes in front of the litter box.

Application Number 1,896,439
Language of Application English

Filing Date 2018-04-30

APPLICANT AND AGENT DETAILS

Applicant

Tyler Gerri Lantz Sound
7535 80 Ave NW
Edmonton
ALBERTA T6C 0S3

Agent

WITMART INC.
34 King Street East, Suite 500, Toronto,
ONTARIO, M5C2X8

TRADEMARK DETAILS

RED ROAD KÂHKÊWAK

Trademark Type

Word

Foreign Character Translation

The translation provided by the applicant of the CREE word KÂHKÊWAK is DRIED MEAT.

Goods

Class 29

Dried meat; Game; Game meat; Smoked meat; Prepared meat; Preserved meat

Application Number 1,896,609
Language of Application English

Filing Date 2018-05-01

APPLICANT AND AGENT DETAILS

Applicant

California Innovations Inc.
36 Dufflaw Road
Toronto
ONTARIO M6A 2W1

Agent

BLAKE, CASSELS & GRAYDON LLP
INTELLECTUAL PROPERTY GROUP, SUITE
4000, COMMERCE COURT WEST, 199 BAY
STREET, TORONTO, ONTARIO, M5L1A9

TRADEMARK DETAILS

ZAZA

Trademark Type

Word

Goods

Class 21

Thermal insulated bags for food or beverages

Application Number 1,897,068
Language of Application English

Filing Date 2018-05-02

APPLICANT AND AGENT DETAILS

Applicant

THE MOUNTAIN CORPORATION, A NEW HAMPSHIRE CORPORATION
59, Optical Avenue
Keene, NH 03431, NH 03431
UNITED STATES OF AMERICA

Agent

VADIS AVOCATS
220-2050 RUE KING OUEST, SHERBROOKE,
QUEBEC, J1J2E8

TRADEMARK DETAILS

Trademark Type

Design

Visual Representation



Colour Claim

Colour is claimed as a feature of the trade-mark. The word PROTECT is in black with the letter 'O' replaced by a circular sun type design in gold.

Goods

Class 18

(1) Tote bags

Class 25

(2) Dresses; Hats; Hoodies; One piece garment for infants and toddlers; Tank tops; Short-sleeved or long-sleeved t-shirts.

Claims

Priority Filing Date: January 02, 2018, Country or Office: UNITED STATES OF AMERICA,
Application No: 87740471 in association with the same kind of goods

Application Number 1,897,221
Language of Application French

Filing Date 2018-05-03

APPLICANT DETAILS

Applicant
CONSTRUCTION GDL INC.
8705 Ch Royal
Sainte-Pétronille
QUÉBEC G0A 4C0

TRADEMARK DETAILS

VSP

Trademark Type
Word

Goods

Class 01

(1) Vinic alcohol.

Class 33

(2) Wine; grape wine; sparkling grape wine; sparkling grape wine; rosé wine; wines; aperitif wines; white wines; dessert wines; table wines; wines and sparkling wines; sparkling wines; rosé wines; red wines; still wines.

Services

Class 44

Operation of a vineyard.

Application Number 1,897,360
Language of Application English

Filing Date 2018-05-03

APPLICANT AND AGENT DETAILS

Applicant

Cinco Corporation
869 Katarungan Street
Plainview, Mandaluyong 1550
PHILIPPINES

Agent

DLA PIPER (CANADA) LLP
Suite 2800, PARK PLACE, 666 BARRARD
STREET, VANCOUVER, BRITISH
COLUMBIA, V6C2Z7

TRADEMARK DETAILS

Trademark Type

Design

Visual Representation



Services

Class 43

Restaurant and catering services

Application Number 1,897,919
Language of Application English

Filing Date 2018-05-07

APPLICANT AND AGENT DETAILS

Applicant

The Vegetarian Butcher Inc.
1007-150 Cordova St E
Vancouver
BRITISH COLUMBIA V6A 0E7

Agent

DRAKE MARKS ASSOCIATES
777 Hornby Street, Suite 600, Vancouver,
BRITISH COLUMBIA, V6Z1S4

TRADEMARK DETAILS

Trademark Type

Design

Visual Representation



Goods

Class 29

(1) prepared meals primarily consisting of cooked fruits and vegetables

Class 30

(2) noodle-based prepared meals

Services

Class 35

(1) retail sale of food

Class 43

(2) bar and cocktail lounge services; catering of food and drinks; restaurant services; take-out restaurant services

Application Number 1,897,924
Language of Application English

Filing Date 2018-05-07

APPLICANT AND AGENT DETAILS

Applicant

1035126 B.C. LTD
2731 Murray St
Port Moody
BRITISH COLUMBIA V3H 1X1

Agent

DRAKE MARKS ASSOCIATES
777 Hornby Street, Suite 600, Vancouver,
BRITISH COLUMBIA, V6Z1S4

TRADEMARK DETAILS

Trademark Type

Design

Visual Representation

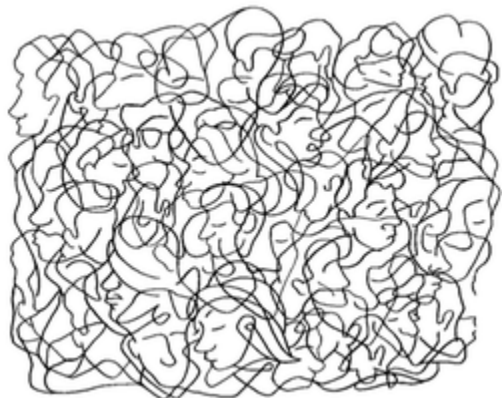

Goods

Class 32

beer, ale, lager, stout and porter

Application Number 1,897,926
Language of Application English

Filing Date 2018-05-07

APPLICANT AND AGENT DETAILS

Applicant

1035126 B.C. LTD
2731 Murray St
Port Moody
BRITISH COLUMBIA V3H 1X1

Agent

DRAKE MARKS ASSOCIATES
777 Hornby Street, Suite 600, Vancouver,
BRITISH COLUMBIA, V6Z1S4

TRADEMARK DETAILS

PARKSICLE

Trademark Type

Word

Goods

Class 32

beer, ale, lager, stout and porter

Application Number 1,898,112
Language of Application English

Filing Date 2018-05-08

APPLICANT AND AGENT DETAILS

Applicant

WHISKY CONNOISSEUR INTERNATIONAL
GROUP
INC.
23749 72ND AVENUE
LANGLEY
BRITISH COLUMBIA V1M 3K9

Agent

ACCUPRO TRADEMARK SERVICES LLP
SUITE 702 - 401 WEST GEORGIA STREET,
VANCOUVER, BRITISH COLUMBIA, V6B5A1

TRADEMARK DETAILS

Trademark Type

Design

Visual Representation



Goods

Class 21

Glass bottles for beverages sold empty, beverage funnels, medallions for bottle identification tagging, namely decanter tags; beverage kits comprising of glass bottles for beverages sold empty, beverage funnels, and medallions for bottle identification tagging, namely decanter tags; gift sets comprising of glass bottles for beverages sold empty, beverage funnels, and medallions for bottle identification tagging, namely decanter tags;

Application Number 1,898,146
Language of Application English

Filing Date 2018-05-09

APPLICANT DETAILS

Applicant
MAPLE LINKNET DISTRIBUTION LTD.
172 Maple Dr
Port Moody
BRITISH COLUMBIA V3H 0A8

TRADEMARK DETAILS

Trademark Type
Design

Visual Representation



Colour Claim

Colour is claimed as a feature of the trade-mark. The drawing above the text 'Oliver Baby': orange. The star symbol in the letter 'i' of the text 'Oliver Baby': orange. The text 'Oliver Baby' except for the star symbol: light blue.

Goods

Class 03

(1) baby bubble bath; baby lotion; baby oils; baby powder; baby shampoo; body lotions; body powders; body wash; bubble bath; essential oils for personal use; hair shampoo; hand soap; lip balm; massage oils; sun protectors for lips; sunscreen; tooth gel; tooth paste

Class 05

(2) antibiotic ointments; anti-inflammatory ointments; hemorrhoidal ointments; insect repellents; ointments for sunburn; ointments for treating diaper rash

Class 21

(3) tooth brushes

Application Number 1,898,936
Language of Application English

Filing Date 2018-05-14

APPLICANT AND AGENT DETAILS

Applicant

YAMAHA HATSUDOKI KABUSHIKI KAISHA
2500 Shingai
Iwata-shi, Shizuoka-ken, 438-8501
JAPAN

Agent

GOWLING WLG (CANADA) LLP
SUITE 2600, 160 ELGIN STREET, OTTAWA,
ONTARIO, K1P1C3

TRADEMARK DETAILS

COMMANDBLUE

Trademark Type

Word

Goods

Class 07

(1) Outboard motors and parts and fittings thereof; electric propulsion systems for boats and ships; electric-motor driven marine propulsion systems.

Class 09

(2) Automatic steering apparatus for boats and ships namely hardware and software for automated steering of boats and ships; telecommunications equipment, namely, remote control apparatus, gauges and steering for LAN systems used in connection with boats and ships namely, electrical controllers, electrical binnacle controllers, electrical throttle controllers, LCD screens, electronic steering controllers, electronic ignition controllers, theft-deterrent systems in the nature of electronic locks, Radio Frequency Identification (RFID) transmitters, Radio Frequency identification (RFID) readers, and joysticks as components of electrical steering controllers; dynamic positioning systems for use with boats and ships; dynamic positioning system hardware and software for use with boats and ships; downloadable software in the nature of a mobile application for use with smart phones and tablet computers for monitoring use and operational status of outboard motors; downloadable software in the nature of a mobile application for use with smart phones and tablet computers for monitoring use and operational status of boats; downloadable software in the nature of a mobile application for use with smart phones and tablet computers for providing maintenance alerts and maintenance reminders to users of outboard motors; downloadable software in the nature of a mobile application for use with smart phones and tablet computers for providing maintenance alerts and maintenance reminders to boat users; downloadable software in the nature of a mobile application for use with smart phones and tablet computers for providing outboard motor operating history, boat location history, notifications of boat condition to boat users and daily maintenance information and maintenance reminders to boat users; downloadable software for monitoring use and operational status of outboard motors; downloadable software for providing maintenance alerts and maintenance reminders to users of outboard motors; downloadable software for providing maintenance alerts and maintenance reminders to boat users; downloadable software for providing outboard motor operating history, boat location history, notifications of boat condition to boat users and daily maintenance information and maintenance reminders to boat users.

Class 12

(3) Propellers for outboard motors; boats and parts and fittings thereof.

Services**Class 42**

Providing temporary use of on-line nondownloadable software for monitoring use and operational status of outboard motors; providing temporary use of on-line nondownloadable software for monitoring use and operational status of boats; providing temporary use of on-line nondownloadable software for providing maintenance alerts and maintenance reminders to users of outboard motors; providing temporary use of online nondownloadable software for providing maintenance alerts and maintenance reminders to boat users; providing temporary use of on-line nondownloadable software for providing outboard motor operating history, boat location history, notifications of boat condition to boat users and daily maintenance information and maintenance reminders to boat users.

Application Number 1,899,041
Language of Application English

Filing Date 2018-05-14

APPLICANT AND AGENT DETAILS

Applicant

Bally Gaming, Inc.
6601 Bermuda Road
Las Vegas, NV 89119
UNITED STATES OF AMERICA

Agent

TORYS LLP
SUITE 3000, 79 WELLINGTON ST. W., BOX
270, TD CENTRE, TORONTO, ONTARIO,
M5K1N2

TRADEMARK DETAILS

GOLD FISH

Trademark Type

Word

Goods

Class 28

Lottery tickets.

Application Number 1,899,472
Language of Application French

Filing Date 2018-05-16

APPLICANT AND AGENT DETAILS

Applicant

L'OREAL, Société anonyme
14 rue Royale
75008 Paris
FRANCE

Agent

FASKEN MARTINEAU DUMOULIN LLP
800 rue Square-Victoria, BUREAU 3700, C.P.
242, MONTREAL, QUÉBEC, H4Z1E9

TRADEMARK DETAILS

NAKED RELOADED

Trademark Type

Word

Goods

Class 03

Make-up products, excluding mascara.

Application Number 1,899,618
Language of Application English

Filing Date 2018-05-17

APPLICANT AND AGENT DETAILS

Applicant

CommScope Technologies LLC
1100 CommScope Place, S.E
Hickory , NC 28602
UNITED STATES OF AMERICA

Agent

VALERIE G. EDWARD
(c/o Ballagh & Edward LLP), 102-175
Longwood Road S., Hamilton, ONTARIO,
L8P0A1

TRADEMARK DETAILS

LAZRSPEED

Trademark Type

Word

Goods

Class 09

fiber optic products, namely, fiber optic cable, patch cords, connectors, outlet connectors, adapters, and splicers; fiber optic cross connect fields, namely, fiber distribution shelves in the form of multiple shelves and jumpers; lightguide interconnect shelves, namely, circuit administrative points that contain optic fibers for routing telephone circuits

Application Number 1,900,046
Language of Application English

Filing Date 2018-05-18

APPLICANT AND AGENT DETAILS

Applicant

CHOICE HOTELS INTERNATIONAL, INC.
(Delaware Corporation)
1 Choice Hotels Circle
Rockville, MD 20850
UNITED STATES OF AMERICA

Agent

GOWLING WLG (CANADA) LLP
SUITE 2600, 160 ELGIN STREET, OTTAWA,
ONTARIO, K1P1C3

TRADEMARK DETAILS

Trademark Type

Design

Visual Representation



Services

Class 43

Hotel and motel services; extended-stay hotel and motel services; hotel and motel reservation services for others; online hotel and motel reservation services for others.

Claims

Priority Filing Date: May 04, 2018, Country or Office: UNITED STATES OF AMERICA, Application No: 87/907,212 in association with the same kind of services

Application Number 1,900,153
Language of Application English

Filing Date 2018-05-22

APPLICANT DETAILS

Applicant

Shenzhen Qianhai Hexin Technology
Co.,Ltd.
Rm.201,Bldg.A,No.1,Qianwan 1st Rd.
Qianhai Shengang Cooperation Zone
Shenzhen,Guangdong
CHINA

TRADEMARK DETAILS

Hosim

Trademark Type

Word

Goods

Class 28

crib mobiles; educational toys; fishing tackle; gaming machines; gymnastic parallel bars; marbles for games; remote-controlled scale model vehicles; resistance machines for exercise; scale model cars; small toys; stuffed toys; toy aircraft; toy building blocks; toy cars; toy masks; toy models; toy pistols; toy trumpets; toy vehicles; toys for pets;

Application Number 1,900,243
Language of Application English

Filing Date 2018-05-22

APPLICANT AND AGENT DETAILS

Applicant

YMCA of Greater Toronto
42 Charles Street East
9th Floor
Toronto
ONTARIO M4Y 1T4

Agent

BORDEN LADNER GERVAIS LLP
World Exchange Plaza, 100 Queen Street,
Suite 1300, Ottawa, ONTARIO, K1P1J9

TRADEMARK DETAILS

Trademark Type

Design

Visual Representation



Goods

Class 09

(1) educational software for children; educational software containing topics of instruction in the fields of art, business, history, geography, linguistics, math, aboriginal studies, career counseling, science, religion, humanities, fitness, and computer technology

Class 16

(2) educational materials, namely, educational books, printed course catalogues, research articles, and printed course materials in the fields of art, business, history, geography, linguistics, math, aboriginal studies, career counseling, science, religion, humanities, fitness, and computer technology; printed publications, namely, books, newsletters, magazines, research periodicals, surveys, and brochures

Class 24

(3) banners of textile and plastic

Services

Class 36

(1) Fundraising services; charitable fundraising services

Class 41

(2) providing education and training services, namely, providing seminars and courses in the fields of art, business, history, geography, linguistics, math, aboriginal studies, career counseling, science, religion, humanities, fitness, and computer technology; conducting training courses for developing and providing leadership; publishing and distributing information, namely, books, magazines, periodicals and text books; operation of a school offering educational and training services, namely, conducting courses of instruction and distance learning at the middle school and high school levels; providing educational information and information on seminars and courses in the fields of art, business, history, geography, linguistics, math, aboriginal studies, career counseling, science, religion, humanities, fitness, and computer technology via social media networking; providing educational and training materials, namely, educational books, downloadable course catalogues and downloadable course materials in the fields of art, business, history, geography, linguistics, math, aboriginal studies, career counseling, science, religion, humanities, fitness, and computer technology via a website; Providing educational software containing topics of instruction in the fields of art, business, history, geography, linguistics, math, aboriginal studies, career counseling, science, religion, humanities, fitness, and computer technology via a website; Providing general educational information in the fields of art, business, history, geography, linguistics, math, aboriginal studies, career counseling, science, religion, humanities, fitness, and computer technology via a website

Application Number 1,900,285
Language of Application English

Filing Date 2018-05-22

APPLICANT AND AGENT DETAILS

Applicant

Board and Brush, LLC
115 Hill Street
Hartland, WI 53029
UNITED STATES OF AMERICA

Agent

CHAD FINKELSTEIN
(DALE & LESSMANN LLP), 181 University
Avenue, Suite 2100, Toronto, ONTARIO,
M5H3M7

TRADEMARK DETAILS

Trademark Type

Design

Visual Representation



Services

Class 41

Do-it-yourself arts and crafts studio that provides the use of supplies and equipment to individuals for making their own arts and crafts.

Application Number 1,900,365
Language of Application English

Filing Date 2018-05-22

APPLICANT AND AGENT DETAILS

Applicant

CHENG SHIN RUBBER IND. CO., LTD.
215, Meei-Kong Road
Ta-Tsun, Chang-Hwa
TAIWAN

Agent

ROBIC
630, boul. René-Lévesque Ouest, 20e étage,
Montréal, QUEBEC, H3B1S6

TRADEMARK DETAILS

SAND SURFER

Trademark Type

Word

Goods

Class 12

ATV (all-terrain vehicle) tires; UTV (utility terrain vehicle) tires.

Claims

Priority Filing Date: May 17, 2018, Country or Office: UNITED STATES OF AMERICA, Application No: 87925693 in association with the same kind of goods

Application Number 1,900,367
Language of Application English

Filing Date 2018-05-22

APPLICANT AND AGENT DETAILS

Applicant

CHENG SHIN RUBBER IND. CO., LTD.
215, Meei-Kong Road
Ta-Tsun, Chang-Hwa
TAIWAN

Agent

ROBIC
630, boul. René-Lévesque Ouest, 20e étage,
Montréal, QUEBEC, H3B1S6

TRADEMARK DETAILS

CARNAGE

Trademark Type

Word

Goods

Class 12

ATV (all-terrain vehicle) tires; UTV (utility terrain vehicle) tires.

Claims

Priority Filing Date: May 17, 2018, Country or Office: UNITED STATES OF AMERICA, Application No: 87925677 in association with the same kind of goods

Application Number 1,900,370
Language of Application English

Filing Date 2018-05-22

APPLICANT AND AGENT DETAILS

Applicant
CHENG SHIN RUBBER IND. CO., LTD.
215, Meei-Kong Road
Ta-Tsun, Chang-Hwa
TAIWAN

Agent
ROBIC
630, boul. René-Lévesque Ouest, 20e étage,
Montréal, QUEBEC, H3B1S6

TRADEMARK DETAILS

WORKZONE

Trademark Type
Word

Goods

Class 12

ATV (all-terrain vehicle) tires; UTV (utility terrain vehicle) tires.

Claims

Priority Filing Date: May 17, 2018, Country or Office: UNITED STATES OF AMERICA, Application No: 87925682 in association with the same kind of goods

Application Number 1,900,371
Language of Application English

Filing Date 2018-05-22

APPLICANT AND AGENT DETAILS

Applicant

GREENWAVE SCIENTIFIC, INC.
2720 DISCOVERY DRIVE
RALEIGH, NC 27616
UNITED STATES OF AMERICA

Agent

BERESKIN & PARR LLP/S.E.N.C.R.L., S.R.L.
SCOTIA PLAZA, 40 KING STREET WEST,
40th FLOOR, TORONTO, ONTARIO, M5H3Y2

TRADEMARK DETAILS

LEAF

Trademark Type

Word

Goods

Class 09

Television antennas.

Application Number 1,900,614
Language of Application English

Filing Date 2018-05-23

APPLICANT DETAILS

Applicant

WINTERGREEN LEARNING MATERIALS LTD.
3075 Line 8
RR2
Bradford
ONTARIO L3Z 3R5

TRADEMARK DETAILS

WINTERGREEN LEARNING MATERIALS

Trademark Type

Word

Goods

Class 02

(1) Paints for arts and crafts.

Class 06

(2) General purpose metal storage bins.

Class 08

(3) All purpose scissors.

Class 09

(4) Educational software for children; Educational software for teachers in the field of structuring lesson plans and evaluating students; Computer games; Downloadable electronic publications, namely, e-books, textbooks, workbooks, worksheets, audio books, articles and newsletters.

Class 16

(5) Photographic and art prints; Paper; Books; Workbooks; Notebooks; Colouring books; Drawing pads; Flashcards; Pens and pencils; Colouring pencils and pens; Marker pens; Paint brushes; Ink stamps; Chalk and chalkboards; Stickers and decals; Modelling clay; Adhesive tapes for stationery purposes; Maps and terrestrial globes; Drawing rulers.

Class 20

(6) Desks; Tables and chairs; Mirrors; Shelving; Boxes of wood and plastic.

Class 21

(7) Sorting and storage trays for educational toys and games.

Class 25

(8) Theatrical costumes; Smocks.

Class 27

(9) Play mats.

Class 28

(10) Educational games for children; Educational toys; Puzzles; Puppets and dolls; Board games; Outdoor activity play sets; Exercise balls; Multiple activity toys for children; Small toys; Toy blocks; Musical toys.

Application Number 1,900,728
Language of Application English

Filing Date 2018-05-24

APPLICANT AND AGENT DETAILS

Applicant

MANI-KRUPA INVESTMENTS INC.
P.O. Box 38
Waterton Park
ALBERTA T0K 2M0

Agent

NORBERT ALTVATER
(ALTVATER LAW OFFICE), 2210 Cedar
Crescent , COALDALE, ALBERTA, T1M0A5

TRADEMARK DETAILS

THIRSTY BEAR KITCHEN + BAR

Trademark Type

Word

Goods

Class 25

Caps; casual and short sleeved shirts.

Services

Class 43

Restaurant, bar and cocktail lounge services.

Application Number 1,902,589
Language of Application English

Filing Date 2018-06-04

APPLICANT AND AGENT DETAILS

Applicant

MR RIGGS WINE COMPANY PTY LTD.
Lot 100 Main Road McLaren Vale
South Australia 5171
AUSTRALIA

Agent

FURMAN IP LAW & STRATEGY PC
300 - 1914 HAMILTON STREET, REGINA,
SASKATCHEWAN, S4P3N6

TRADEMARK DETAILS

ABUNDANCE

Trademark Type

Word

Goods

Class 33

wine

Application Number 1,902,861
Language of Application English

Filing Date 2018-06-06

APPLICANT DETAILS

Applicant

VIEMO SCALED ANALYTICS INC.
555 Legget Dr Suite 304 - Tower A
Kanata
ONTARIO K2K 2X3

TRADEMARK DETAILS

Sky Analyst

Trademark Type

Word

Services

Class 42

cloud computing providing software for database management; computer programming and software design; design and development of computer software; design, development and implementation of software; preparation, update, installation and maintenance of computer software; rental and updating of software for data processing; rental of computer software; rental of software for data processing; updating and rental of software for data processing; updating of computer software; updating of software for data processing; upgrading of computer software; writing and updating computer software

Application Number 1,903,739
Language of Application English

Filing Date 2018-06-11

APPLICANT DETAILS

Applicant

Alan Duprat
591 Calvin Crt
Burnaby
BRITISH COLUMBIA V5A 3Y8

TRADEMARK DETAILS

Trademark Type

Design

Visual Representation



Colour Claim

Colour is claimed as a feature of the trademark. Copper- The phone, the magnifying glass, the cross hairs, the vibrations and the two dots above the ë ('diaeresis'). Black- musical note and text in black.

Goods

Class 09

(1) smart phones; smart rings; smart watches; telephone smart cards; watch batteries

Class 14

(2) automatic watches; bands for watches; bracelets for watches; buckles for watch bands; buckles for watch straps; cases for clocks and watches; cases for watches and clocks; clocks and watches; dials for watches; digital watches; diving watches; dress watches; faces for watches; gold watches; jewellery and watches; jewellery watches; jewelry watches; leather watch bands; leather watch straps; mechanical and automatic watches; mechanical watches; men's watches; metal watch bands; metal watch straps; movements for clocks and watches; movements for watches and clocks; oscillators for watches; pendulums for watches; plastic watch bands; plastic watch straps; platinum watches; pocket watches; presentation boxes for watches; silver watches; sports watches; stop watches; straps for watches; watch bands; watch bands and straps; watch boxes; watch bracelets; watch cases; watch cases of precious metal; watch cases of precious metal or coated therewith; watch chains; watch clasps; watch crowns; watch crystals; watch dials; watch faces; watch fobs; watch glasses; watch hands; watch movements; watch parts; watch pouches; watch presentation boxes; watch springs; watch straps; watch straps made of metal or leather or plastic; watch winders; watch winding buttons; watches; watches and clocks; watches and jewellery; watches and straps for watches; watches containing a game function; watches

containing an electronic game function; watches for men; watches for outdoor use; watches for sporting use; watches for women; watches made of precious metals or coated therewith; women's watches; wrist watches

Application Number 1,904,695
Language of Application English

Filing Date 2018-06-18

APPLICANT DETAILS

Applicant

Serena Haddad
132 Shaw St
Toronto
ONTARIO M6J 2W5

TRADEMARK DETAILS

fast farm

Trademark Type

Word

Services

Class 39

(1) delivery of food by restaurants

Class 43

(2) bar and restaurant services; business catering services; cafe-restaurants; cafés; carry-out restaurants; fast-food restaurants; mobile cafe services for providing food and drink; mobile catering services; mobile restaurant services; outside catering services; restaurants; restaurants featuring home delivery; take-away restaurant services; take-out restaurant services

Application Number 1,905,115
Language of Application English

Filing Date 2018-06-19

APPLICANT AND AGENT DETAILS

Applicant

10601977 Canada Inc
39 Eastbourne Ave
Beaconsfield
QUEBEC H9W 5G8

Agent

DAVID DURAND
(Durand Morisseau s.e.n.c.r.l./LLP), 3 Place
Ville-Marie, Suite 400, Montréal, QUEBEC,
H3B2E3

TRADEMARK DETAILS

cbderm

Trademark Type

Word

Goods

Class 03

cosmetic creams for firming skin around eyes; cosmetic creams for skin care; cosmetic oils for the skin; cosmetic preparations for skin renewal; emulsions, gels and lotions for skin care; moisturising skin lotions; moisturizing skin lotions; non-medicated preparations for the care of skin; non-medicated skin care preparations; non-medicated skin creams; skin care cosmetics; skin care creams; wrinkle removing skin care preparations

Application Number 1,905,445
Language of Application English

Filing Date 2018-06-20

APPLICANT DETAILS

Applicant

Slick Spaces Technologies Inc
306-151 West First Ave
Vancouver
BRITISH COLUMBIA V5Y 0A5

TRADEMARK DETAILS

Slickspaces

Trademark Type

Word

Disclaimer

The right to the exclusive use of the word Slickspaces or slickspaces.com is disclaimed apart from the trademark.

Services

Class 42

software as a service (SAAS) provider in the field of providing customer relations management;
software design and development

Application Number 1,905,460
Language of Application English

Filing Date 2018-06-20

APPLICANT DETAILS

Applicant

William Code
71 Garden Dr
Barrie
ONTARIO L4N 5T9

TRADEMARK DETAILS

Johnson's Creek

Trademark Type

Word

Services

Class 41

entertainment in the form of live musical concerts; entertainment in the form of live performances by a musical band

Application Number 1,905,953
Language of Application English

Filing Date 2018-06-26

APPLICANT DETAILS

Applicant
WESTERN CANADIAN WIND CHIMES INC.
211 Madeira Close NE
Calgary
ALBERTA T2A 4N7

TRADEMARK DETAILS

MODCHIMES

Trademark Type
Word

Goods
Class 20
wind chimes

Application Number 1,906,816
Language of Application English

Filing Date 2018-06-28

APPLICANT AND AGENT DETAILS

Applicant

Kevin Estrella
38-69 Augusta St.
Hamilton
ONTARIO L8N 1R1

Agent

MILTONS IP/P.I.
15 Fitzgerald Rd, Suite 200, Ottawa,
ONTARIO, K2H9G1

TRADEMARK DETAILS

PYRAMIDS ON MARS

Trademark Type

Word

Goods

Class 09

(1) CD music recordings; compact discs containing music; digital music downloadable from internet; downloadable music; downloadable music files.

Class 16

(2) Posters and decals.

Class 21

(3) Mugs.

Class 25

(4) T-shirts, beanies and caps.

Services

Class 38

(3) Live audio streaming and pre-recorded podcast streaming audio of radio interviews via a website; streaming of audio and video namely music.

(4) Streaming of live performances by a musical band and music instruction via a website.

Class 41

(1) Music instruction.

(2) Entertainment in the form of live musical concerts; entertainment in the form of live performances by a musical band.

Application Number 1,907,283
Language of Application English

Filing Date 2018-07-03

APPLICANT DETAILS

Applicant

Hangzhou Lingrui Hotel Management Co.,
Ltd
Room 202, No. 224 Siyanjing, Xihu
District, Hangzhou City
Zhejiang Province
CHINA

TRADEMARK DETAILS

Trademark Type

Design

Visual Representation



Colour Claim

Colour is claimed as a feature of the trade-mark. The trademark is in brown.

Foreign Character Translation

As provided by the applicant, the English translation of the Chinese characters is 'DULL' and 'CICADA'.

Foreign Character Transliteration

As provided by the applicant, the transliteration of Chinese characters is 'DAI CHAN'.

Services

Class 43

agency services for booking hotel accommodation; bar services; café services; cafeteria services; canteen services; hotel services; providing campground facilities; rental of chairs, tables, table linen, glassware; self-service restaurant services; washoku restaurant services

Application Number 1,908,231
Language of Application English

Filing Date 2018-07-09

APPLICANT DETAILS

Applicant

Lisa Ali
201 Main St
Mahone Bay
NOVA SCOTIA B0J 2E0

TRADEMARK DETAILS

TickPick

Trademark Type

Word

Goods

Class 21

insect traps

Application Number 1,908,247
Language of Application English

Filing Date 2018-07-09

APPLICANT AND AGENT DETAILS

Applicant

HMPTN WATER, LLC, a legal entity
c/o Sussman & Associates
700 12th Avenue South
Suite 201
Nashville, TN 37203
UNITED STATES OF AMERICA

Agent

RICHEs, MCKENZIE & HERBERT LLP
SUITE 1800, 2 BLOOR STREET EAST,
TORONTO, ONTARIO, M4W3J5

TRADEMARK DETAILS

Trademark Type

Design

Visual Representation



Goods

Class 33

wine

Claims

Priority Filing Date: February 14, 2018, Country or Office: UNITED STATES OF AMERICA,
Application No: 87/798,254 in association with the same kind of goods

Application Number 1,908,850
Language of Application English

Filing Date 2018-07-11

APPLICANT DETAILS

Applicant

Rodrigo Munoz
13612 228 St
Maple Ridge
BRITISH COLUMBIA V4R 0B5

TRADEMARK DETAILS

Trademark Type

Design

Visual Representation



Foreign Character Translation

The translation provided by the applicant of the word(s) Cutis Sanus is Healthy Skin.

Goods

Class 03

beauty serums

Application Number 1,908,931
Language of Application English

Filing Date 2018-07-11

APPLICANT DETAILS

Applicant

Jeff Leroux
2113 Bracken Rd
Harrowsmith
ONTARIO K0H 1V0

TRADEMARK DETAILS

Trademark Type

Design

Visual Representation



Goods

Class 29

goat milk; milk and milk products

Application Number 1,909,438
Language of Application English

Filing Date 2018-07-13

APPLICANT AND AGENT DETAILS

Applicant

Eftihia Effie Takas
8 Coxwell Blvd
East York
ONTARIO M4C 3G7

Agent

WILSON VUKELICH LLP
VALLEYWOOD CORPORATE CENTRE, 60
COLUMBIA WAY, SUITE 710, MARKHAM,
ONTARIO, L3R0C9

TRADEMARK DETAILS

YIAYIA APPROVED

Trademark Type

Word

Foreign Character Translation

The translation provided by the applicant of the Greek word(s) YIAYIA is Grandmother.

Goods

Class 09

(1) cell phone cases

Class 14

(2) key chain tags

Class 16

(3) packaging boxes of cardboard; packaging boxes of paper; packaging containers of paper

Class 20

(4) packaging containers of plastic

Class 22

(5) packaging bags of textile material

Class 25

(6) casual shirts; hats; promotional t-shirts; t-shirts

Class 30

(7) bread and pastry; coffee; cookies; doughnuts; sandwiches

(8) gelato, loukoumades, specialty pies

Services

Class 43

cafés; coffee shop services

Application Number 1,909,567
Language of Application English

Filing Date 2018-07-16

APPLICANT DETAILS

Applicant

Dylan Murray
571 jessie ave
Winnipeg
MANITOBA R3L 0R1

TRADEMARK DETAILS

Jump Pack

Trademark Type

Word

Services

Class 35

(1) advertising and business management consultancy; business management consulting with relation to strategy, marketing, production, personnel and retail sale matters; business marketing consulting services; business organisation and management consulting services; providing marketing consulting in the field of social media; social media strategy consulting

Class 42

(2) computer software consulting

Application Number 1,909,652
Language of Application English

Filing Date 2018-07-16

APPLICANT AND AGENT DETAILS

Applicant

Jordan Lu
915-8833 Hazelbridge Way
Richmond
BRITISH COLUMBIA V6X 0N3

Agent

FILLMORE RILEY LLP
1700 - 360 Main Street, Winnipeg, MANITOBA,
R3C3Z3

TRADEMARK DETAILS

Trademark Type

Design

Visual Representation



Goods

Class 05

(1) adhesive bands for medical purposes; adhesives for dentures; compresses; dental abrasives; dental amalgams; dental amalgams of gold; dental cements; dental impression materials; dental lacquer; dental mastics; medicated mouthwash; molding wax for dentists; moleskin for medical purposes; porcelain for dental prostheses; preparations to facilitate teething; rubber for dental purposes; salts for mineral water baths; teeth filling material

Class 25

(2) athletic clothing; bath robes; beach clothes; belts; boots; boxer shorts; business clothing; capes; caps; coats; dress clothing; dresses; gloves; hats; hosiery; jackets; muffler scarves; neckties; overcoats; pants; parkas; pullovers; scarves; shirts; shoes; short-sleeve shirts; skirts; skorts; slippers; socks; socks and stockings; sports jerseys; sports shoes; sports singlets; sweat-absorbent socks; sweaters; tee-shirts; tights; underpants; underwear; waistcoats; waterproof jackets; waterproof pants

Application Number 1,909,772
Language of Application English

Filing Date 2018-07-16

APPLICANT DETAILS

Applicant

Jonathan Simard
3030B 13th Ave.
Regina
SASKATCHEWAN S4T 1N9

TRADEMARK DETAILS

Novasphere

Trademark Type

Word

Goods

Class 14

ear studs

Application Number 1,909,782
Language of Application English

Filing Date 2018-07-17

APPLICANT AND AGENT DETAILS

Applicant

Xiamen city Siming District Wangbashu
Restaurant
No.50, West Lianban Commercial Plaza,
Siming District, Xiamen City
CHINA

Agent

WITMART INC.
34 King Street East, Suite 500, Toronto,
ONTARIO, M5C2X8

TRADEMARK DETAILS

Trademark Type

Design

Visual Representation



旺巴蜀
WANG BA SHU

Foreign Character Translation

As provided by the applicant, the English translation of the Chinese characters is "prosperous" (first character), "hope" (second character) and "name of an ancient state" (third character).

Foreign Character Transliteration

As provided by the applicant, the transliteration of the Chinese characters is "WANG BA SHU".

Goods

Class 29

(1) broth; butter; dried truffles; edible fats; eggs; fish; soups; tinned meat; vegetable soup preparations

Class 30

(2) coffee; food seasonings; instant rice; noodles; pastries; seasonings; tea

Services

Class 43

bar services; café services; canteen services; hotel services

Application Number 1,909,784
Language of Application English

Filing Date 2018-07-17

APPLICANT AND AGENT DETAILS

Applicant

Shanghai Zhen Lei Industrial Co. Ltd.
J-346,3F,No.93 Lane 901,Kangye Rd.,
Zhujiajiao Town,Qingpu Dist.
Shanghai
CHINA

Agent

MILTONS IP/P.I.
15 Fitzgerald Rd, Suite 200, Ottawa,
ONTARIO, K2H9G1

TRADEMARK DETAILS

Trademark Type

Design

Visual Representation

The image shows the handwritten trademark 'Song Tang Peony' in a stylized, cursive script. The characters are black and appear to be written with a brush or thick marker. The 'S' and 'T' are particularly large and prominent.

Goods

Class 25

casual clothing; coats; girdles; hats; hosiery; scarves; shoes; theatrical costumes; underwear; wind coats

Application Number 1,909,863
Language of Application English

Filing Date 2018-07-17

APPLICANT DETAILS

Applicant
CAALCO DISTRIBUTORS CORPORATION
9 Fawnhaven Court
Toronto
ONTARIO M2R 3R6

TRADEMARK DETAILS

RADA

Trademark Type
Word

Foreign Character Translation
As provided by the applicant, the English translation of the word RADA is "COUNCIL".

Goods
Class 33
vodka

Application Number 1,909,922
Language of Application English

Filing Date 2018-07-17

APPLICANT DETAILS

Applicant

ONEZO INTERNATIONAL INC.
1104-9830 Whalley Blvd
Surrey
BRITISH COLUMBIA V3T 5S7

TRADEMARK DETAILS

Trademark Type

Design

Visual Representation

Dirty Tea
脏脏茶

Foreign Character Translation

As provided by the applicant, the English translation of the first two Chinese characters, reading from left to right, and when used together, is "dirty" and the English translation of the third Chinese character is "tea".

Foreign Character Transliteration

As provided by the applicant, the transliteration of the three Chinese characters, reading from left to right, is "Zang Zang Cha".

Goods

Class 29

(1) candied fruit; cheese; fried chicken; frozen fruits; frozen meat; fruit bars; fruit chips; fruit jelly; fruit salads; milk and milk products; milk beverages containing fruits; milk beverages with high milk content; milk powder for food purposes; milkshakes; soft cheese; soy milk; soy-based beverage for use as a milk substitute

Class 30

(2) artificial coffee and tea; baking-powder; barley tea; beverages made of coffee; beverages made of tea; black tea; bread; chocolate; cocoa powder; coffee and tea; coffee beverages with milk; cones for ice cream; frozen yoghurt; fruit jelly candy; fruit teas; ginger tea; honey; ice cream; iced coffee; iced tea; Japanese green tea; jasmine tea; non-alcoholic chocolate-based beverages; non-alcoholic coffee-based beverages; non-alcoholic tea-based beverages; oolong tea; sugar; sugar confectionery; tapioca; tapioca flour for food; tea

Class 32

(3) aerated water; bottled water; coconut water; frozen fruit drinks; fruit drinks and juices; fruit flavoured drinks; fruit-based drinks; ginger beer; grape juice; grapefruit juice; iced fruit drinks; lemon juice; lemonade; non-alcoholic beverages containing fruit juices; non-alcoholic beverages flavored with coffee; non-alcoholic beverages flavored with tea; orange juice; peach juice; pineapple juice; smoothies; soda pop; tomato juice; vegetable juices

Services**Class 35**

(1) administration of customer loyalty programs; administration of frequent flyer programs; advertising agency services; advertising and business management consultancy; advertising on the Internet for others; advertising the goods and services of others; advertising the goods and services of others via electronic media and specifically the internet; advice relating to the organisation and management of business; advisory services for business management; business administration and management; business administration consulting services; business administration services; business invoicing services; business management advisory services relating to franchising; business management and organization consultancy; business management assistance; business organization and management consulting; business organization and operation consultancy; business planning; computerised database management; computerized database management; construction cost management; cost analysis; cost/price analysis; human resources consulting services; human resources management; invoicing services; leasing of office equipment; market analysis; providing business information in the field of social media; providing focus group services; rental of advertising space; retail sale of food

Class 43

(2) bar services; cafeteria services; catering services; fast-food restaurants; food and drink catering; rental of bar equipment; restaurant services; restaurants; self-service restaurants; snack-bar services; take-out restaurant services; tea bar services; tea rooms; teahouse services

Application Number 1,910,195
Language of Application English

Filing Date 2018-07-18

APPLICANT DETAILS

Applicant

WN Pharmaceuticals Ltd.
2000 Brigantine Drive
Coquitlam
BRITISH COLUMBIA V3K 7B5

TRADEMARK DETAILS

DIGITAL DEFENSE

Trademark Type

Word

Goods

Class 05

dietary supplements for general health and well-being; herbal supplements for general health and well-being; nutritional supplements for general health and well-being

Application Number 1,910,259
Language of Application English

Filing Date 2018-07-18

APPLICANT AND AGENT DETAILS

Applicant

St. Urbain Bagel Bakery Ltd
7-1311 Alness St
Concord
ONTARIO L4K 1E8

Agent

KATE HENDERSON
128 Vine Avenue, Toronto, ONTARIO, M6P1V7

TRADEMARK DETAILS

APPLELINI

Trademark Type

Word

Goods

Class 30

cakes

Application Number 1,910,288
Language of Application English

Filing Date 2018-07-18

APPLICANT DETAILS

Applicant

lukas zapata
9631 79 St
Edmonton
ALBERTA T6C 2S1

TRADEMARK DETAILS

Serene Luna

Trademark Type

Word

Goods

Class 24

(1) bed blankets

Class 25

(2) casual clothing

Application Number 1,910,313
Language of Application English

Filing Date 2018-07-18

APPLICANT DETAILS

Applicant

Hangzhou Wormhole Import and Export
Trading Co., Ltd.
2-304 #553 Yingbinlu Nanyuan Street,
Yuhang
Hangzhou
CHINA

TRADEMARK DETAILS

Wormhole

Trademark Type

Word

Goods

Class 08

body piercing equipment; ear piercing apparatus; ear piercing equipment; ear-piercing apparatus;
ear-piercing guns; ear-piercing needles; hex wrenches; manicure implements; manicure sets;
manicure tools; razors; razors and razor blades; screw wrenches; screwdrivers; socket wrenches;
sword scabbards; tattoo needles; tattooing needles; tool handles; tool handles of plastic

Application Number 1,910,316
Language of Application English

Filing Date 2018-07-18

APPLICANT DETAILS

Applicant

Hangzhou Wormhole Import and Export
Trading Co., Ltd.
2-304 #553 Yingbinlu Nanyuan Street,
Yuhang
Hangzhou
CHINA

TRADEMARK DETAILS

PADIEOE

Trademark Type

Word

Goods

Class 08

body piercing equipment; ear piercing apparatus; ear piercing equipment; ear-piercing apparatus;
ear-piercing guns; ear-piercing needles; hex wrenches; manicure implements; manicure sets;
manicure tools; razors; razors and razor blades; screw wrenches; screwdrivers; socket wrenches;
sword scabbards; tattoo needles; tattooing needles; tool handles; tool handles of plastic

Application Number 1,910,319
Language of Application English

Filing Date 2018-07-19

APPLICANT DETAILS

Applicant

Iryna Rudavska
324 20th St W
North Vancouver
BRITISH COLUMBIA V7M 1Y5

TRADEMARK DETAILS

TETRIS MORTGAGES

Trademark Type

Word

Services

Class 36

mortgage banking; mortgage brokerage; mortgage refinancing; mortgage services

Application Number 1,910,331
Language of Application English

Filing Date 2018-07-19

APPLICANT DETAILS

Applicant

Shenzhen Riitek Investment Co.,Ltd
Room405,4F,No.1
Building,ZhongkenuoIndustry Park
Hezhou Development Zone,Xixiang
Street,Baoan District
Shenzhen
CHINA

TRADEMARK DETAILS

ankbit

Trademark Type

Word

Goods

Class 09

automotive battery chargers; battery chargers for use with telephones; blank smart cards; cabinets for loudspeakers; computer cases; computer hardware; computer keyboards; computer mouse; computer software and databases for use in diagnosis, repair and configuration of computers; computer utility file storage programs; computers; electronic pens; general purpose batteries; headphones; integrated circuit identification cards; mouse pads; smartglasses; stands adapted for mobile phones

Application Number 1,910,333
Language of Application English

Filing Date 2018-07-19

APPLICANT AND AGENT DETAILS

Applicant

Shenzhen Anhengpu Technology Co., Ltd.
A303, Derong Pavilion, Dexing Garden,
Xihuan Rd., Buji St., Longgang Dist.,
Shenzhen
CHINA

Agent

WITMART INC.
34 King Street East, Suite 500, Toronto,
ONTARIO, M5C2X8

TRADEMARK DETAILS

Perfectmiaoxuan

Trademark Type

Word

Goods

Class 09

(1) cases for smartphones; eyeglass cases; eyeglasses; headphones; protective films adapted for smart phones; stands adapted for mobile phones; sunglasses; video projectors; wireless headsets for smartphones; wireless headsets for use with smartphones

Class 20

(2) clothes hangers; playpens for babies

Class 21

(3) cloths for cleaning; drinking bottles for sports; gloves for household purposes

Class 25

(4) bathing suits; bathing trunks; brassières; casual clothing; pajamas

Application Number 1,910,545
Language of Application English

Filing Date 2018-07-19

APPLICANT AND AGENT DETAILS

Applicant

Drip More, LLC
1110 Palmyrita Ave, Ste 120
Riverside, CA 92507
UNITED STATES OF AMERICA

Agent

ROBERT ANTON NISSEN
(Nissen Patent Law), Suite 200, 10328 - 81
Avenue, Edmonton, ALBERTA, T6E1X2

TRADEMARK DETAILS

TOBACCO LIFE

Trademark Type

Word

Goods

Class 34

(1) Electronic cigarette liquid (e-liquid) comprised of flavorings in liquid form, other than essential oils, used to refill electronic cigarette cartridges; Electronic cigarette liquid (e-liquid) comprised of propylene glycol; Electronic cigarette liquid (e-liquid) comprised of vegetable glycerin;
(2) cartridges sold filled with chemical flavorings in liquid form for electronic cigarettes; chemical flavourings in liquid form used to refill electronic cigarette cartridges; liquid nicotine solutions for use in electronic cigarettes

Application Number 1,910,596
Language of Application English

Filing Date 2018-07-20

APPLICANT AND AGENT DETAILS

Applicant

Rachelle Wintzenrieth
70 McGee St
Toronto
ONTARIO M4M 2K9

Agent

SOTOS LLP
SUITE 1200, 180 DUNDAS ST. WEST,
TORONTO, ONTARIO, M5G1Z8

TRADEMARK DETAILS

FUN THINGS MAKE YOU SWEAT

Trademark Type

Word

Goods

Class 04

(1) candles

Class 16

(2) postcards

Class 18

(3) tote bags

Class 21

(4) coffee mugs

Class 25

(5) hats; t-shirts

Services

Class 41

conducting fitness classes

Application Number 1,910,678
Language of Application English

Filing Date 2018-07-20

APPLICANT AND AGENT DETAILS

Applicant

Home Depot International, Inc.
2455 Paces Ferry Road, NW
Atlanta, GA 30339
UNITED STATES OF AMERICA

Agent

BERESKIN & PARR LLP/S.E.N.C.R.L., S.R.L.
SCOTIA PLAZA, 40 KING STREET WEST,
40th FLOOR, TORONTO, ONTARIO, M5H3Y2

TRADEMARK DETAILS

STYLEWELL

Trademark Type

Word

Goods

Class 04

Candles

Application Number 1,910,679
Language of Application English

Filing Date 2018-07-20

APPLICANT AND AGENT DETAILS

Applicant

Home Depot International, Inc.
2455 Paces Ferry Road, NW
Atlanta, GA 30339
UNITED STATES OF AMERICA

Agent

BERESKIN & PARR LLP/S.E.N.C.R.L., S.R.L.
SCOTIA PLAZA, 40 KING STREET WEST,
40th FLOOR, TORONTO, ONTARIO, M5H3Y2

TRADEMARK DETAILS

STYLEWELL

Trademark Type

Word

Goods

Class 06

Metal brackets for window blinds and curtain rods; metal knobs; metal shelf brackets; metal door hardware, namely, stoppers, hinges, jambs, chain door guards, deadbolts, kick plates, latches, door knockers, handles, and knobs; metal storage hooks

Application Number 1,910,680
Language of Application English

Filing Date 2018-07-20

APPLICANT AND AGENT DETAILS

Applicant

Home Depot International, Inc.
2455 Paces Ferry Road, NW
Atlanta, GA 30339
UNITED STATES OF AMERICA

Agent

BERESKIN & PARR LLP/S.E.N.C.R.L., S.R.L.
SCOTIA PLAZA, 40 KING STREET WEST,
40th FLOOR, TORONTO, ONTARIO, M5H3Y2

TRADEMARK DETAILS

STYLEWELL

Trademark Type

Word

Goods

Class 08

Flatware; table cutlery

Application Number 1,910,681
Language of Application English

Filing Date 2018-07-20

APPLICANT AND AGENT DETAILS

Applicant

Home Depot International, Inc.
2455 Paces Ferry Road, NW
Atlanta, GA 30339
UNITED STATES OF AMERICA

Agent

BERESKIN & PARR LLP/S.E.N.C.R.L., S.R.L.
SCOTIA PLAZA, 40 KING STREET WEST,
40th FLOOR, TORONTO, ONTARIO, M5H3Y2

TRADEMARK DETAILS

STYLEWELL

Trademark Type

Word

Goods

Class 11

Electric lighting fixtures; lamps; lamp shades; sconce lighting fixtures; electric night lights;
bathroom exhaust fans

Application Number 1,910,682
Language of Application English

Filing Date 2018-07-20

APPLICANT AND AGENT DETAILS

Applicant

Home Depot International, Inc.
2455 Paces Ferry Road, NW
Atlanta, GA 30339
UNITED STATES OF AMERICA

Agent

BERESKIN & PARR LLP/S.E.N.C.R.L., S.R.L.
SCOTIA PLAZA, 40 KING STREET WEST,
40th FLOOR, TORONTO, ONTARIO, M5H3Y2

TRADEMARK DETAILS

STYLEWELL

Trademark Type

Word

Goods

Class 14

Clocks

Application Number 1,910,688
Language of Application English

Filing Date 2018-07-20

APPLICANT AND AGENT DETAILS

Applicant

Home Depot International, Inc.
2455 Paces Ferry Road, NW
Atlanta, GA 30339
UNITED STATES OF AMERICA

Agent

BERESKIN & PARR LLP/S.E.N.C.R.L., S.R.L.
SCOTIA PLAZA, 40 KING STREET WEST,
40th FLOOR, TORONTO, ONTARIO, M5H3Y2

TRADEMARK DETAILS

STYLEWELL

Trademark Type

Word

Goods

Class 24

Bed linens; kitchen linens, namely, table napkins of textile, textile place mats, kitchen towels of textile, textile tablecloths, fabric table runners; bath linens, namely, bath towels, bath mats, toilet lid covers, shower curtains; pillows; drapery; indoor and outdoor curtains; mattress pads; shower curtain liners; bed blankets; throws

Application Number 1,910,689
Language of Application English

Filing Date 2018-07-20

APPLICANT AND AGENT DETAILS

Applicant

Home Depot International, Inc.
2455 Paces Ferry Road, NW
Atlanta, GA 30339
UNITED STATES OF AMERICA

Agent

BERESKIN & PARR LLP/S.E.N.C.R.L., S.R.L.
SCOTIA PLAZA, 40 KING STREET WEST,
40th FLOOR, TORONTO, ONTARIO, M5H3Y2

TRADEMARK DETAILS

STYLEWELL

Trademark Type

Word

Goods

Class 26

Artificial flowers

Application Number 1,910,690
Language of Application English

Filing Date 2018-07-20

APPLICANT AND AGENT DETAILS

Applicant

Home Depot International, Inc.
2455 Paces Ferry Road, NW
Atlanta, GA 30339
UNITED STATES OF AMERICA

Agent

BERESKIN & PARR LLP/S.E.N.C.R.L., S.R.L.
SCOTIA PLAZA, 40 KING STREET WEST,
40th FLOOR, TORONTO, ONTARIO, M5H3Y2

TRADEMARK DETAILS

STYLEWELL

Trademark Type

Word

Goods

Class 27

Wallpaper

Application Number 1,910,803
Language of Application English

Filing Date 2018-07-20

APPLICANT DETAILS

Applicant

Kent Heinrichs
Unit 510- HEINRICHS
3310 8th St. East
Saskatoon
SASKATCHEWAN S7H 5M3

TRADEMARK DETAILS

Trademark Type

Design

Visual Representation

CROSSFLEX

Goods

Class 14

(1) bracelets; jewelry; jewelry rings; necklaces; presentation boxes for jewellery; presentation boxes for watches; watches

Class 25

(2) hats; shirts

Application Number 1,910,952
Language of Application English

Filing Date 2018-07-23

APPLICANT DETAILS

Applicant

Christopher Pestano, Marlon Abalos
1258 Garcia St
Mississauga
ONTARIO L5V 2W8

TRADEMARK DETAILS

cityyz

Trademark Type

Word

Goods

Class 25

athletic apparel; athletic clothing; baby clothing; casual clothing; casual clothing featuring pants, dresses and shorts; children's clothing

Services

Class 35

online sales of clothing

Application Number 1,910,968
Language of Application English

Filing Date 2018-07-23

APPLICANT DETAILS

Applicant

Anthony Lewis
38 Luella Cres
Brampton
ONTARIO L7A 3H7

TRADEMARK DETAILS

The DNA Project

Trademark Type

Word

Services

Class 41

arranging and conducting musical concerts; entertainment in the form of live performances by a musical band; entertainment services in the nature of live performances by a musical band; musical floor shows provided at performance venues; organization of music concerts for charitable purposes; performances featuring live dance and live music; production of live musical variety shows

Application Number 1,910,975
Language of Application English

Filing Date 2018-07-23

APPLICANT AND AGENT DETAILS

Applicant

Village Farms L.P.
195 International Parkway
Heathrow, FL 32746
UNITED STATES OF AMERICA

Agent

GOWLING WLG (CANADA) LLP
SUITE 1600, 1 FIRST CANADIAN PLACE, 100
KING STREET WEST, TORONTO, ONTARIO,
M5X1G5

TRADEMARK DETAILS

MAVERICK MIX

Trademark Type

Word

Goods

Class 31

fresh tomatoes

Application Number 1,912,252
Language of Application English

Filing Date 2018-07-30

APPLICANT AND AGENT DETAILS

Applicant

Unilever Canada Inc.
160 Bloor Street East
Suite 1400
Toronto
ONTARIO M4W 3R2

Agent

BAKER & MCKENZIE LLP
BROOKFIELD PLACE, 181 BAY STREET,
SUITE 2100, P.O. BOX 874, TORONTO,
ONTARIO, M5J2T3

TRADEMARK DETAILS

Trademark Type

Design

Visual Representation



Goods

Class 03

(1) Soaps, namely, toilet soaps, body care soaps, liquid hand soaps, detergents, namely, laundry detergents, body powder, hair and body lotion, hair care preparations, shampoos, conditioners and hair conditioners, hair detanglers, toothpaste, grooming products for mouth and teeth, namely, dentifrices, beauty products for bath and shower, namely, body wash and shower gel, baby care preparations, namely, baby oil, preparations, oils, creams and lotions for the care of hair, body and skin, hair oil and hair cream, cosmetics, talcum powder, tissues and wipes for cosmetic use, wetted cleansing wipes, namely, baby wipes, and all intended for babies and children.

Class 05

(2) Diapers, baby napkins; medicinal preparations for treatment of head lice and skin acne; ointments and creams and lotions to diaper rash, medicated creams and lotions for the skin, namely, skin care preparations for the treatment of skin irritation; petroleum jelly for personal use, petroleum jelly for cosmetic use, all aforementioned products for babies and children.

Application Number 1,912,516
Language of Application English

Filing Date 2018-07-31

APPLICANT AND AGENT DETAILS

Applicant

NAIL ALLIANCE, LLC
6840 N. Oak
Gladstone, MO 64118
UNITED STATES OF AMERICA

Agent

GOWLING WLG (CANADA) LLP
SUITE 1600, 1 FIRST CANADIAN PLACE, 100
KING STREET WEST, TORONTO, ONTARIO,
M5X1G5

TRADEMARK DETAILS

Trademark Type

Design

Visual Representation



Colour Claim

Colour is claimed as a feature of the trade-mark. The colours PANTONE* pink 203U and 1905U, PANTONE* purple 2352C and 19-3438TPG, PANTONE* blue 2389C, PANTONE* green 2270U and PANTONE* yellow 2296U and 100C are being claimed as a feature of the trademark. PANTONE* is a registered trademark. The colours listed above apply in the order listed to the circles which form the trademark starting from the top.

Goods

Class 03

Cosmetics; non-medicated nail care preparations and nail acrylic, gel, enamel; Beauty supplies, namely, nail care kits composed primarily of UV top coat, nail primer, nail dehydrator, and also containing assorted nail forming tools and instruction booklet.

Claims

Priority Filing Date: January 31, 2018, Country or Office: UNITED STATES OF AMERICA, Application No: 87778645 in association with the same kind of goods

Application Number 1,918,177
Language of Application English

Filing Date 2018-09-04

APPLICANT AND AGENT DETAILS

Applicant

Unilever Canada Inc.
160 Bloor Street East
Suite 1400
Toronto
ONTARIO M4W 3R2

Agent

BAKER & MCKENZIE LLP
BROOKFIELD PLACE, 181 BAY STREET,
SUITE 2100, P.O. BOX 874, TORONTO,
ONTARIO, M5J2T3

TRADEMARK DETAILS

Trademark Type

Design

Visual Representation



Goods

Class 03

Soaps, namely, toilet soaps, facial soaps, body care soaps, liquid hand soap; cleaning preparations, namely, skin cleanser, perfumery, toilet water, aftershave, cologne; essential oils for personal use; aromatherapy products, namely, aromatherapy oils and lotions; massage preparations; deodorants and antiperspirants for personal use; preparations for the care of the scalp and hair; shampoos and conditioners; hair colorants; hair styling preparations; toothpaste; mouthwash; preparations for the care of the mouth and teeth; non-medicated toilet preparations namely, perfumed body spray; bath and shower preparations, namely, body wash and shower gel; skin care preparations; oils, creams and lotions for the skin; shaving preparations; pre-shave and aftershave preparations; depilatory preparations; sun-tanning and sun protection preparations; cosmetics; make-up and make-up removing preparations; petroleum jelly for personal use; lip care preparations; talcum powder; cotton wool, cotton sticks; pre-moistened cleansing pads for personal use; beauty masks, facial packs.

Application Number 1,922,443
Language of Application English

Filing Date 2018-09-27

APPLICANT AND AGENT DETAILS

Applicant

Unilever Canada Inc.
160 Bloor Street East
Suite 1400
Toronto
ONTARIO M4W 3R2

Agent

BAKER & MCKENZIE LLP
BROOKFIELD PLACE, 181 BAY STREET,
SUITE 2100, P.O. BOX 874, TORONTO,
ONTARIO, M5J2T3

TRADEMARK DETAILS

Trademark Type

Design

Visual Representation

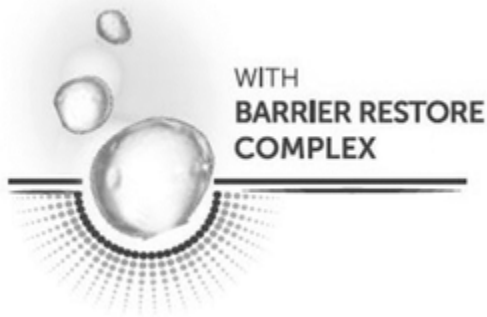

Goods

Class 03

Skin care preparations; oils, creams and lotions for the skin; petroleum jelly for cosmetic use.

Application Number 1,922,444
Language of Application English

Filing Date 2018-09-27

APPLICANT AND AGENT DETAILS

Applicant

Unilever Canada Inc.
160 Bloor Street East
Suite 1400
Toronto
ONTARIO M4W 3R2

Agent

BAKER & MCKENZIE LLP
BROOKFIELD PLACE, 181 BAY STREET,
SUITE 2100, P.O. BOX 874, TORONTO,
ONTARIO, M5J2T3

TRADEMARK DETAILS

Trademark Type

Design

Visual Representation

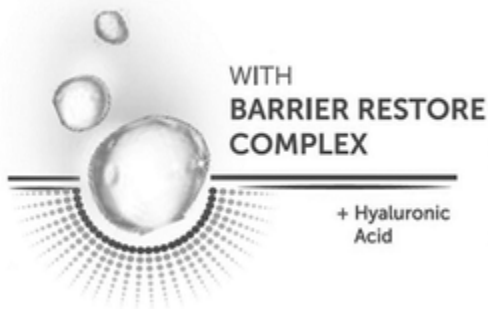

Goods

Class 03

Skin care preparations; oils, creams and lotions for the skin; petroleum jelly for cosmetic use.

Application Number 1,922,447
Language of Application English

Filing Date 2018-09-27

APPLICANT AND AGENT DETAILS

Applicant

Unilever Canada Inc.
160 Bloor Street East
Suite 1400
Toronto
ONTARIO M4W 3R2

Agent

BAKER & MCKENZIE LLP
BROOKFIELD PLACE, 181 BAY STREET,
SUITE 2100, P.O. BOX 874, TORONTO,
ONTARIO, M5J2T3

TRADEMARK DETAILS

Trademark Type

Design

Visual Representation

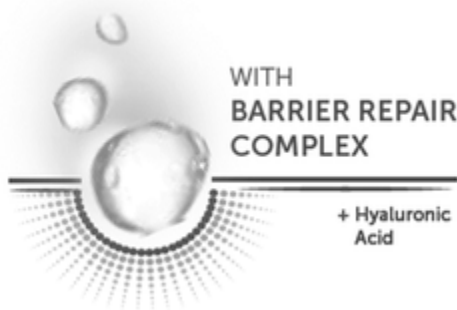

Goods

Class 03

Skin care preparations; oils, creams and lotions for the skin; petroleum jelly for cosmetic use.

Application Number 1,923,749
Language of Application English

Filing Date 2018-10-05

APPLICANT AND AGENT DETAILS

Applicant

Unilever Canada Inc.
160 Bloor Street East
Suite 1400
Toronto
ONTARIO M4W 3R2

Agent

BAKER & MCKENZIE LLP
BROOKFIELD PLACE, 181 BAY STREET,
SUITE 2100, P.O. BOX 874, TORONTO,
ONTARIO, M5J2T3

TRADEMARK DETAILS

Trademark Type

Design

Visual Representation



Goods

Class 03

(1) Soaps, namely, toilet soaps, body care soaps, liquid hand soaps, detergents, namely, laundry detergents, body powder, hair and body lotion, hair care preparations, shampoos, conditioners and hair conditioners, hair detanglers, toothpaste, grooming products for mouth and teeth, namely, dentifrices, beauty products for bath and shower, namely, body wash and shower gel, baby care preparations, namely, baby oil, preparations, oils, creams and lotions for the care of hair, body and skin, hair oil and hair cream, cosmetics, talcum powder, tissues and wipes for cosmetic use, wetted cleansing wipes, namely, baby wipes; and all intended for babies and children.

Class 05

(2) Diapers, baby napkins; medicinal preparations for treatment of head lice and skin acne; ointments and creams and lotions to diaper rash, medicated creams and lotions for the skin, namely, skin care preparations for the treatment of skin irritation; petroleum jelly for personal use, petroleum jelly for cosmetic use, all aforementioned products for babies and children

Application Number 1,927,184
Language of Application English

Filing Date 2018-10-25

APPLICANT AND AGENT DETAILS

Applicant

Home Depot International, Inc.
2455 Paces Ferry Road, NW
Atlanta, GA 30339
UNITED STATES OF AMERICA

Agent

BERESKIN & PARR LLP/S.E.N.C.R.L., S.R.L.
SCOTIA PLAZA, 40 KING STREET WEST,
40th FLOOR, TORONTO, ONTARIO, M5H3Y2

TRADEMARK DETAILS

Trademark Type

Design

Visual Representation

StyleWell.

Goods

Class 04

Candles

Application Number 1,927,186
Language of Application English

Filing Date 2018-10-25

APPLICANT AND AGENT DETAILS

Applicant

Home Depot International, Inc.
2455 Paces Ferry Road, NW
Atlanta, GA 30339
UNITED STATES OF AMERICA

Agent

BERESKIN & PARR LLP/S.E.N.C.R.L., S.R.L.
SCOTIA PLAZA, 40 KING STREET WEST,
40th FLOOR, TORONTO, ONTARIO, M5H3Y2

TRADEMARK DETAILS

Trademark Type

Design

Visual Representation

StyleWell.

Goods

Class 08

Flatware; table cutlery

Application Number 1,927,198
Language of Application English

Filing Date 2018-10-25

APPLICANT AND AGENT DETAILS

Applicant

Home Depot International, Inc.
2455 Paces Ferry Road, NW
Atlanta, GA 30339
UNITED STATES OF AMERICA

Agent

BERESKIN & PARR LLP/S.E.N.C.R.L., S.R.L.
SCOTIA PLAZA, 40 KING STREET WEST,
40th FLOOR, TORONTO, ONTARIO, M5H3Y2

TRADEMARK DETAILS

Trademark Type

Design

Visual Representation

StyleWell.

Goods

Class 27

Wallpaper; area rugs

Application Number 1,930,738
Language of Application English

Filing Date 2018-11-15

APPLICANT AND AGENT DETAILS

Applicant

Hästens Sängar AB
P.O. Box 130
731 23 Köping
SWEDEN

Agent

SMART & BIGGAR LLP
1000 RUE DE LA GAUCHETIERE OUEST,
BUREAU 3300, MONTREAL, QUEBEC,
H3B4W5

TRADEMARK DETAILS

EMBRACE CHAOS

Trademark Type

Word

Goods

Class 20

(1) Furniture and furnishings, namely, bedroom furniture, beds, bed frames, bedsteads, mattresses, spring mattresses, overlay mattresses, mattress toppers, pillows, down pillows and cushions

Class 24

(2) Textile goods and substitutes for textile goods, namely, bed linen, bed throws, bed spreads, duvets, duvet covers, comforters, sleeping bag liners, pillowcases, mattress covers, bed valances, bed skirts, bed canopies, bedroom curtains, plaided blankets, quilts, blankets, throws, down quilts, towels, namely, bath towels, cloth towels, face towels, cotton towels, hand towels

Application Number 1,935,823
Language of Application English

Filing Date 2018-12-13

APPLICANT AND AGENT DETAILS

Applicant

Apple Inc.
One Apple Park Way
Cupertino, CA 95014
UNITED STATES OF AMERICA

Agent

BAKER & MCKENZIE LLP
BROOKFIELD PLACE, 181 BAY STREET,
SUITE 2100, P.O. BOX 874, TORONTO,
ONTARIO, M5J2T3

TRADEMARK DETAILS

Trademark Type

Design

Visual Representation



Colour Claim

Colour is claimed as a feature of the trade-mark. The mark consists of a diamond shape with a turquoise background on the left hand side shading to blue on the right hand side on the diamond shape's surface and the letters 'ML' in white in the centre of the diamond-shaped surface. Also in the diamond shape's surface are white lines and dots. Descending below the diamond surface shape are three V shapes shading downwards in colour from dark turquoise for the top V shape, to medium turquoise for the middle V shape to light turquoise for the bottom V shape.

Goods

Class 09

computer software used in developing other software applications; application development software

Claims

Priority Filing Date: June 15, 2018, Country or Office: JAMAICA, Application No: 75258 in association with the same kind of goods

Application Number 1,938,412
Language of Application English

Filing Date 2018-12-28

APPLICANT AND AGENT DETAILS

Applicant

Alnylam Pharmaceuticals, Inc.
300 Third Street
Cambridge, MA 02142
UNITED STATES OF AMERICA

Agent

MACRAE & CO.
P.O. BOX 806, STATION B, 222 SOMERSET
STREET WEST, SUITE 600, OTTAWA,
ONTARIO, K2P2G3

TRADEMARK DETAILS

Trademark Type

Design

Visual Representation



Goods

Class 05

Pharmaceutical preparations for the treatment of porphyria.

Claims

Priority Filing Date: December 20, 2018, Country or Office: UNITED STATES OF AMERICA,
Application No: 88/237,293 in association with the same kind of goods

Application Number 1,964,362
Language of Application English

Filing Date 2019-05-22

APPLICANT DETAILS

Applicant

KYLE WOODS
2557 Hogan Crt
Burlington
ONTARIO L7M 4T5

TRADEMARK DETAILS

RSRV

Trademark Type

Word

Goods

Class 09

Computer and cellular telephone software for booking tables at nightclubs, ordering food and beverages, purchasing tickets to nightclub events, keeping track of and setting limits on spending, processing electronic payments for products and services, showing the user's location on a map, showing the locations of bars and nightclubs on a map and navigation instructions to these businesses, viewing information about and receiving notifications from bar and nightclub businesses, rating and reviewing bars and nightclubs, viewing expected wait times for getting into busy nightclubs, viewing and sharing photographs, creating and viewing guest lists for nightclubs, and for allowing proprietors and serving staff to view the personal details and purchase information of patrons at nightclubs

Services

Class 35

Providing digital advertising space for the products and services of others in the form of suggestions and promoted search results within a cellular telephone application; Providing online advertising space for the products and services of others

Application Number 1,964,367
Language of Application English

Filing Date 2019-05-22

APPLICANT AND AGENT DETAILS

Applicant

VITRUVI CORPORATION
1100 - 915 WEST GEORGIA STREET
VANCOUVER
BRITISH COLUMBIA V6C 3L2

Agent

ACCUPRO TRADEMARK SERVICES LLP
SUITE 702 - 401 WEST GEORGIA STREET,
VANCOUVER, BRITISH COLUMBIA, V6B5A1

TRADEMARK DETAILS

Trademark Type

Design

Visual Representation



Goods

Class 03

(1) Aromatherapy oils in sprays, mists and roll-on applicators; home and body cleaning preparations, namely body scrubs, body lotions, body oils, hair shampoos, countertop spray, kitchen cleaner, namely oven cleaner, glass cleaner, spray cleaner for household purposes, air fragrancing preparations, floor polish;

Class 21

(2) Porcelain aromatherapy diffusers and misters;

Application Number 1,967,155
Language of Application English

Filing Date 2019-06-05

APPLICANT AND AGENT DETAILS

Applicant

OMGs Candy Inc.
8 - 1377 Border Street
Winnipeg
MANITOBA R3H 0N1

Agent

RONALD S. ADE LAW CORPORATION
102 - 1015 Wilkes Avenue, Winnipeg,
MANITOBA, R3P2R8

TRADEMARK DETAILS

Trademark Type

Design

Visual Representation



Colour Claim

Colour is claimed as a feature of the trade-mark. The letter 'o' is in the color ORANGE (Pantone #PMS 715), the letter 'm' is in the color PURPLE (Pantone #PMS 7656), the letter 'g' is in the color PINK (Pantone #PMS 7422), and the exclamation mark is in the color ORANGE (Pantone #PMS 715). PANTONE is a registered trademark.

Goods

Class 30

(1) candy

(2) chocolate bars; popcorn; brownie squares; cookies; cereal-based snack food; ice cream.

Applications to extend the statement of goods or services

Application Number 1,011,734(01)
Registration Number TMA540,676
Language of Application English

Filing Date 2016-05-12

APPLICANT AND AGENT DETAILS**Applicant**

Neal's Yard (Natural Remedies) Limited,
15 Neal's Yard,
Covent Garden,
London WC2H 9DP,
UNITED KINGDOM

Agent

GUY & MUZZO INC.
6455, avenue Christophe-Colomb, bureau 206,
Montréal, QUEBEC, H2S2G5

TRADEMARK DETAILS**Trademark Type**

Design

Visual Representation**Goods****Class 03**

(1) All purpose cleaning polishing, scouring and abrasive preparations, essential oils for aromatherapy and personal use, essences namely perfumes, shampoo, avocado oils, perfumed oils for aromatherapy and personal use, bath oils, bath foams, pumice stones for cleaning, perfumed talcum powder, face soap, body soap, hand soap, face scrubs, body deodorant, cleaners namely face washes, body washes, body scrubs, face scrubs, toothpaste, mouthwash, creams for face, body, hands and feet, body moisturizers, face moisturizers, hand moisturizers, feet moisturizers, hair lotions, scents for aromatherapy and personal use, toilet waters, aromatherapy products, namely scented oils, scented creams, scented body lotion, massage oil;

powders, namely scented body powders, nail polish, nail polish removers, shaving and after shave preparations, pot pourri, incense sticks, baby oils, non medicated baby creams, cosmetic wipes, cotton wool for cosmetic purposes, after sun preparations, hydrating face atomizers.

Class 05

(2) Pharmaceutical preparations for the treatment of mood disorders, the treatment of mental stress, treatment of depression, for the treatment of anxiety, for the alleviation of sleep disorders, for the treatment and improvement of psychological well-being, the treatment and improvement of physical wellbeing; sanitary preparations for medical purposes, namely desinfectant soap, astringents for medical purposes, analgesic balms, bath salts, medicated hair care preparations namely medicinal hair growth preparations, medicinal hair growth shampoos, medicinal hair growth serum, medicinal hair growth lotions and medicinal hair growth pomades, articulation and joint creams for the relief of pain, skin cleansing lotions for medical use, anti-bacterial wound cleansers, antiseptics, antibacterial soaps and cleansers, disinfecting preparations for hands, feet, skin and body, namely sanitizers having anti-bacterial, anti-microbial properties; dietetic substances adapted for medical use, namely, dietetic foods for medical use, namely prepared meals consisting of cooked fruits, vegetable and meat, diet pills and capsules, minerals and vitamins; material for stopping teeth, dental wax; medicated essential oils (non pharmaceutical) for the treatment of mood disorders, the treatment of mental stress, treatment of depression, for the treatment of anxiety, for the alleviation of sleep disorders, for the treatment and improvement of psychological well-being, the treatment and improvement of physical wellbeing, essential oils (non pharmaceutical) for the treatment of mood disorders, the treatment of mental stress, treatment of depression, for the treatment of anxiety, for the alleviation of sleep disorders, for the treatment and improvement of psychological well-being, the treatment and improvement of physical wellbeing; tinctures for medical purposes, namely, for the treatment of mood disorders, for the treatment of mental stress, for the treatment of depression, for the treatment of anxiety, for the treatment and improvement of psychological well-being, for the treatment and improvement of physical wellbeing; Alcoholic spirits infused with plant extracts for medical purposes and alcoholic spirits infused with natural extracts for medical purposes namely stellaria (chickweed) tincture, hypericum (St-john's wort) tincture, calendula tincture, arnica tincture; air fresheners, herbal oils, herbs and flowers for the alleviation and treatment of emotional and mental stress, depression and sleep disorders and for psychological wellbeing and physical wellbeing; poultices, cough remedies, Homeopathic remedies for the treatment of colds, Medicated hair lotions for the treatment of dandruff; Medicated hair shampoos for the treatment of dandruff; pharmaceutical preparations derived from natural substances for alleviating emotional and mental stress, depression and sleep disorders, for psychological wellbeing and physical wellbeing, for the relief of pain and for the treatment of cough, cold, flu, flu-like symptoms, fever, chills, sinus, runny nose, sneezing, nasal discharge, nervousness, restlessness, mental fatigue, skin irritations (namely bee stings, sunburn, rashes, sores, corns and calluses), minor cuts, blisters, bruises, burns, wounds, muscle soreness and sprains, tendonitis, muscles stiffness, diarrhea, headaches and migraine, inflammation, arthritis, eczema, acne, cystitis, gas, indigestion, nausea, bloating, varicose veins, hemorrhoids, allergies, constipation, stomach aches, nerve pain, insect bites and stings, infections, asthma, sore throat, menstrual symptoms, sties (gland infections), skin rashes, eye trauma, bone trauma, teething, warts; preparations derived from natural substances for the treatment of mood disorders, the treatment of mental stress, treatment of depression, for the treatment of anxiety, for the alleviation of sleep disorders, for the treatment and improvement of psychological well-being, the treatment and improvement of physical wellbeing; Allopathic and homeopathic remedies for the treatment of mood disorders, the treatment of mental stress, treatment of depression, for the treatment of anxiety, for the alleviation of sleep disorders, for the treatment and improvement of psychological

well-being, the treatment and improvement of physical wellbeing; vitamins and nutritional supplements for general health and well-being; food supplements, namely, dietary supplements in liquid form for general health and well-being, vitamin and mineral dietary supplements in liquid form; plants and flowers for use in the alleviation and treatment of emotional and mental stress, depression and sleep disorders and for psychological well-being and physical wellbeing; mineral supplements, medicated drinks and foodstuffs, namely herbal tea, chewing gum, throat lozenges, sweets in the form of candy, gum sweets, candy gels, gel candy filled with liquid centres, hard candy, all derived from natural substances, plants and flower sources, for use in the alleviation and treatment of emotional and mental stress, depression and sleep disorders and for psychological well-being and physical wellbeing; antiseptics, all-purpose disinfectants, Preparations for detecting allergies for medical purposes; Bee pollen used as dietary supplement.

Class 11

(3) Air humidifiers, air diffusers, facial steamers

Class 16

(4) Paper, cardboard; Printed matter namely, art prints, graphic prints, printed publications in the field of health wellbeing, aromatherapy, cosmetics, pharmaceuticals, greeting cards, calendars, diaries, brochures, graphic novels, memo pads, medical publications, articles, books, magazines, newspapers; bookbinding material; photographs; stationery namely, paper, envelopes, pens, pencils, rulers, erasers; Plastic bags for packaging, plastic film for packaging, absorbent sheets of plastic for foodstuff packaging; printing blocks, gift boxes, books about health care, cooking, psychology, beauty, homeopathic remedies, and nutrition, herbs and plants, massage, vaccinations, pregnancy, fragrances, reflexology, baby care, drugs, food, information leaflets, pamphlets, newsletters, gift wrapping, teaching and instructional materials namely, printed publication in the field of health, wellbeing, aromatherapy, cosmetics, pharmaceuticals, calendars, greeting cards, posters, gift labels, magazines.

Class 21

(5) Household or kitchen utensils and containers (not of precious metal or coated therewith) namely, plastic bottles, water bottles sold empty and oil bottles, jars, candleholders; hair combs and bath sponges; cosmetic brushes; articles for cleaning the body namely cleaning and exfoliating mitts, cleaning cloths, loofahs for bathing, tub brushes, bath sponges; steelwool; unworked or semi-worked glass (except glass used in building); Glassware, porcelain and earthenware not included in other classes namely, drinking glasses, cups, saucers, candleholders, hair brushes, bath brushes, loofas for bathing, nail brushes, body brush bristles, pumps to dispense essential oils, essences in the form of perfumes, shampoo, massage oils, avocado oils, perfumed oils, bath oils, bath foams, skin and hand soap, face scrubs, hair conditioner, body deodorants, cleaners namely face washes, body washes, body scrubs, face scrubs, toothpaste, mouthwash, creams for face, body, hands, or feet, body moisturizers, hair lotions, toilet waters, eau de cologne, nail polish, nail polish removers, shaving and after shave preparations, baby oils, non medicated baby creams, after sun preparations, massage oils, tinctures, air fresheners, vitamins, mineral supplements, antiseptics; dispensers to dispense essential oils, essences in the form of perfumes, shampoo, massage oils, avocado oils, perfumed oils, bath oils, bath foams, skin and hand soap, face scrubs, hair conditioner, body deodorants, cleaners namely face washes, body washes, body scrubs, face scrubs, toothpaste, mouthwash, creams for face, body, hands, or feet, body moisturizers, hair lotions, toilet waters, eau de cologne, nail polish, nail polish removers, shaving and after shave preparations, baby oils, non medicated baby creams, after sun preparations, essential oils (non pharmaceutical), massage oils, tinctures, air fresheners, vitamins, mineral supplements, antiseptics; atomizers to dispense essential oils, essences in the form of

perfumes, perfumed oils, both oils, deodorants, cleaners namely face washes, body moisturizers, hair lotions, toilet waters, eau de cologne, essential oils (non pharmaceutical), massage oils, tinctures, air fresheners, plastic bottles, water bottles sold empty and oil bottles, jars, dropper bottles sold empty, aroma burners made of ceramic, aroma burners made of glass, atomizers for water, atomizers for perfumes, tea infusers, incense burners, aroma burners, tea strainer (cloth). Household or kitchen utensils and containers (not of precious metal or coated therewith) namely, plastic bottles, water bottles sold empty and oil bottles, jars, candleholders; hair combs and bath sponges; cosmetic brushes; articles for cleaning the body namely cleaning and exfoliating mitts, cleaning cloths, loofahs for bathing, tub brushes, bath sponges; steelwool; unworked or semi-worked glass (except glass used in building); Glassware, porcelain and earthenware not included in other classes namely, drinking glasses, cups, saucers, candleholders, hair brushes, bath brushes, loofas for bathing, nail brushes, body brush bristles, pumps to dispense essential oils, essences in the form of perfumes, shampoo, massage oils, avocado oils, perfumed oils, bath oils, bath foams, skin and hand soap, face scrubs, hair conditioner, body deodorants, cleaners namely face washes, body washes, body scrubs, face scrubs, toothpaste, mouthwash, creams for face, body, hands, or feet, body moisturizers, hair lotions, toilet waters, eau de cologne, nail polish, nail polish removers, shaving and after shave preparations, baby oils, non medicated baby creams, after sun preparations, massage oils, tinctures, air fresheners, vitamins, mineral supplements, antiseptics; dispensers to dispense essential oils, essences in the form of perfumes, shampoo, massage oils, avocado oils, perfumed oils, bath oils, bath foams, skin and hand soap, face scrubs, hair conditioner, body deodorants, cleaners namely face washes, body washes, body scrubs, face scrubs, toothpaste, mouthwash, creams for face, body, hands, or feet, body moisturizers, hair lotions, toilet waters, eau de cologne, nail polish, nail polish removers, shaving and after shave preparations, baby oils, non medicated baby creams, after sun preparations, essential oils (non pharmaceutical), massage oils, tinctures, air fresheners, vitamins, mineral supplements, antiseptics; atomizers to dispense essential oils, essences in the form of perfumes, perfumed oils, both oils, deodorants, cleaners namely face washes, body moisturizers, hair lotions, toilet waters, eau de cologne, essential oils (non pharmaceutical), massage oils, tinctures, air fresheners, plastic bottles, water bottles sold empty and oil bottles, jars, dropper bottles sold empty, aroma burners made of ceramic, aroma burners made of glass, atomizers for water, atomizers for perfumes, tea infusers, incense burners, aroma burners, tea strainer (cloth).

Class 24

(6) Textiles and textile goods namely, massage mitts, flannels, face cloths, wash cloths massage mitts, bath towels, hand towels, cotton towels, ayate cloth, muslin face cloth, cotton cloths.

Class 29

(7) Meat, fish, poultry and game; meat extracts; preserved, dried and cooked fruits and vegetables; jellies, jams, compotes; eggs, milk and milk products; edible oils and fats, creams, preparations of natural origin used in the making of beverages, food and beverages in this class.

Class 30

(8) Tea, cereal, honey, instant tea, tisanes, herbal infusions, herbs and dried herbs for food purposes, spices

Class 31

(9) Mustard seeds, Chia seeds, Fennel seeds, Cumin seeds, Caraway seeds, Coriander seeds, Dill seeds, Celery seeds, Psyllium seeds, Hemp seed oil, Grape seed extract, Celery seed, Milk thistle herb seed, Flaxseed seeds, Linseed seeds, Oats seeds, Rosehip seeds, natural plants and flowers; malt extract for food; vegetable roots and other roots namely burdock, stone, orris, wild yam, Echinacea Angustifolia, Echinacea Purpurea, marshmallow, dandelion, gentian, calamus,

gravel, beth, hydrangea, valerian, mahonia (Oregon grape), angelica, rehmannia, fleecflower, yellow dock, rhodiola rosea, bayberry, blue flag and bilberry roots for food, aromatic and flavouring purposes; Oak bark, cherry bark, barberry bark, white willow bark, cramp bark, prickly ash bark, quassia chips; vegetable and fruit peels used for food, aromatic and flavouring purposes; berries, flowers, dried flowers; vegetable and tree nuts used for food, aromatic and flavouring purposes; Olive leaf, comfrey leaf, birch leaf, senna leaf, burdock leaf, marshmallow leaf, bay leaf, coltsfoot leaf, green tea leaf, raspberry leaf, witchhazel leaf, walnut leaf, sweet violet leaf, dandelion leaf, alfalfa leaf, shrubs.

Class 33

(10) Alcoholic beverages (except beers), tinctures, alcoholic beverages infused with plant extracts, alcoholic beverages infused with natural extracts

Services

Class 35

(1) Advertising namely advertising agencies, promoting the sale of goods and services through promotional contests and the distribution of related printed material, promoting the sale of goods and services through a consumer loyalty program, promoting the sale of goods and services by awarding purchase points for credit card use and promoting the sale of goods and services through the distribution of discount cards; Business and management advice, assistance and information services namely business management assistance, commercial assistance in business management, management and operation assistance to commercial businesses, advice relating to the organisation and management of business, advice in the field of business management and marketing and advice and information concerning commercial business management; Franchising, namely offering technical assistance for the establishment, operating of retail stores or salons, mail order, retail and Internet retail services; mail order, retail and Internet retail services in the field of cleaning polishing, scouring and abrasive preparations, essential oils, essences in the form of perfumes, shampoo, massage oils, avocado oils, perfumed oils, bath oils, bath foams, pumice stones for cleaning, talcum powder, perfumed talcum powder, soap, face scrubs, hair conditioner, deodorant, cleaners namely face washes, body washes, body scrubs, face scrubs, toothpaste, mouthwash, creams for face, body, hands, or feet, moisturizers, hair lotions, scents, toilet waters, eau de cologne, aromatherapy products, powders, nail polish, nail polish removers, shaving and after shave preparations, bath salts, pot pourri, incense sticks, baby oils, non medicated baby creams, cosmetic wipes, cotton wool for cosmetic purposes, pharmaceutical preparations, sanitary preparations for medical purposes, dietetic substances adapted for medical use, food for babies, material for stopping teeth, dental wax, after sun preparations, medicated oils (non pharmaceutical), essential oils (non pharmaceutical) for treatment of ailments, massage oils, tinctures, air fresheners, herbal oils adapted for medical use, herbs for medical uses, flowers for medical uses, poultices, face atomizers, hand creams (medicated), face creams (medicated), body creams (medicated), foot creams (medicated), cough remedies, remedies for colds, moisturizers, medicated hair lotions, medicated hair shampoos, preparations derived from natural substances for remedial purposes, preparations derived from natural substances for the treatment of psychological disorders or conditions, allopathic remedies, homeopathic remedies, vitamins and nutrients, food supplements, mineral supplements, medicated drinks, medicated foods, antiseptics, disinfectants, diagnostic preparations for medical purposes, apparatus for lighting, heating, steam generating, cooking, refrigerating, drying, ventilating, water supply and sanitary purposes, incense burners, aroma burners, steamers, paper, cardboard and goods made from these materials, not included in other classes, printed matter, bookbinding material, photographs, stationery, plastic materials for packaging (not included in other classes), printing blocks, gift boxes, books about

health care, cooking, psychology, beauty, homeopathic remedies and nutrition, herbs and plants, massage, vaccinations, pregnancy, fragrances, reflexology, baby care, drugs, food, information leaflets, pamphlets, newsletters, wrapping and packaging materials, teaching and instructional materials, calendars, greeting cards, posters, gift labels, magazines, household or kitchen utensils and containers (not of precious metal or coated therewith), combs and sponges, brushes (except paint brushes), brush-making materials, articles for cleaning purposes, steelwool, unworked or semi-worked glass (except glass used in building), glassware, porcelain and earthenware not included in other classes, hair brushes, bath brushes, loofas, nail brushes, body bristles, pumps, dispensers, atomizers, bottles, jars, pipettes, droppers, aroma burners made of pot, aroma burners made of glass, atomizers for water, atomizers for perfumes, infusion containers, textiles and textile goods, massage mitts, towels, ayate cloth, muslin face cloth, cotton cloths, tea strainer (cloth), tea, preparations made from cereals, tisanes, infusions, dried herbs, shrubs, seeds, natural plants and flowers, foodstuffs for animals, malt, spices, herbs, teas, roots, bark, peels, berries, flowers, dried flowers, seeds, nuts, pollen, leaf, tinctures, beverages infused with plant extracts, beverages infused with natural extracts.

Class 41

(2) Entertainment in the field of events relating to health products, beauty products, nutrition and franchising; education namely, massage courses, aromatherapy courses, nutrition courses, herbal remedies courses, homeopathy courses, courses about flower essences, courses about herbal remedies, courses about nutrition, courses about natural perfumery, courses about massage, courses about natural skincare, courses about homeopathy; Meditation training; Organizing and operating educational conferences, seminars and workshops in the field of franchising; Publishing namely, book publishing, article publishing, magazine publishing, newspaper publishing; audio and video recording services; examining for and granting of professional and educational qualifications and awards for having completed massage courses, aromatherapy courses, nutrition courses, herbal remedies courses, homeopathy courses, courses about flower essences, courses about herbal remedies, courses about natural vitality, courses about nutrition, courses about natural perfumery, courses about massage, courses about natural skincare, courses about homeopathy; Ticket reservation and booking for marketing events, for educational courses and training and for cultural events namely workshops and seminars in the field of massage, aromatherapy, nutrition, herbal remedies, homeopathy, flower essences, natural vitality, natural perfumery, natural skincare, franchising, publishing, audio and video recording, photography; Arranging and providing information, research, advice and assistance in the field of event panning, namely events relating to health products, beauty products, nutrition and franchising; Educational courses and training in the field of massage, aromatherapy, nutrition, herbal remedies, homeopathy, flower essences, natural vitality, natural perfumery, natural skincare, franchising, publishing, audio and video recording, photography.

Class 44

(3) Medical and healthcare services namely, medical clinic, consulting services in the field of remedies, psychological and psychiatric services; homeopathic clinics; alternative and complementary medicine and therapy services namely acupressure, acupuncture, allergy testing, aromatherapy massage, baby massage, body massage, chair massage, chiropractic, cognitive behavioural therapy, cranial osteopathy, craniosacral therapy, ear candling, facials, facial rejuvenation massage, facial revitalisation (acupuncture), flower essence therapy, foresight preconception care, dispensing of herbal medicine, homoeopathy, hypnotherapy, Indian head massage, kinesiology, life coaching, manual lymphatic drainage, massage, naturopathic nutrition, neuro linguistic programming, neuro structural integration technique, nutritional therapy and allergy testing, osteopathy, physiotherapy, Pilates, podiatry, pre and post natal massage, reflexology,

Rolfing, shiatsu, Thai massage, Tui Na massage, yoga; Providing health care information in the field of natural remedies; beauty, hair and nail salon services; manicure, pedicure and hairdressing services; massage services; sun tanning services; aromatherapy services; advisory services relating to diet, exercise, fitness, lifestyle, healthcare, stress, beauty and hygiene; physical therapy; Making reservations and booking for medical clinics, consulting services in the field of remedies, psychological and psychiatric services, homeopathic clinics, hygienic and beauty care services namely beauty salon services, beauty, hair and nail salon services, manicure services, pedicure services, hairdressing services, massage services, sun tanning services, aromatherapy services.

Public notices under section 9 of the *Trademarks Act*

Application Number 925,734

PROHIBITED MARK DETAILS

The Registrar hereby gives public notice under subparagraph 9(1)(n)(iii) of the Trademarks Act, of the adoption and use in Canada by Coaching Association of Canada of the mark shown here, as an official mark for goods and services.

Application Number 925,735

PROHIBITED MARK DETAILS



The Registrar hereby gives public notice under subparagraph 9(1)(n)(iii) of the Trademarks Act, of the adoption and use in Canada by COACHING ASSOCIATION OF CANADA of the mark shown here, as an official mark for goods and services.

Application Number 925,742

PROHIBITED MARK DETAILS

ChPC

The Registrar hereby gives public notice under subparagraph 9(1)(n)(iii) of the Trademarks Act, of the adoption and use in Canada by Coaching Association of Canada of the mark shown here, as an official mark for goods and services.

Application Number 925,744

PROHIBITED MARK DETAILS

THE LOCKER

The Registrar hereby gives public notice under subparagraph 9(1)(n)(iii) of the Trademarks Act, of the adoption and use in Canada by Coaching Association of Canada of the mark shown here, as an official mark for goods and services.

Application Number 925,750

PROHIBITED MARK DETAILS

PNCE

The Registrar hereby gives public notice under subparagraph 9(1)(n)(iii) of the Trademarks Act, of the adoption and use in Canada by Coaching Association of Canada of the mark shown here, as an official mark for goods and services.

Application Number 925,814

PROHIBITED MARK DETAILS



The Registrar hereby gives public notice under subparagraph 9(1)(n)(iii) of the Trademarks Act, of the adoption and use in Canada by The Algoma District School Board of the mark shown here, as an official mark for goods and services.

Application Number 925,815

PROHIBITED MARK DETAILS

ALGOMA DISTRICT SCHOOL BOARD

The Registrar hereby gives public notice under subparagraph 9(1)(n)(iii) of the Trademarks Act, of the adoption and use in Canada by The Algoma District School Board of the mark shown here, as an official mark for goods and services.

Application Number 925,836

PROHIBITED MARK DETAILS



The Registrar hereby gives public notice under subparagraph 9(1)(n)(iii) of the Trademarks Act, of the adoption and use in Canada by College of Physicians and Surgeons of Ontario of the mark shown here, as an official mark for goods and services.

Foreign Character Translation

The translation provided by the requesting party of the words FIDUS IN ARCANIS is "faithful in the mysteries".

Erratum

The following issues of the Trademarks Journal contained errors which could not be corrected before publication.

2019-12-18**Application Number** 1,901,021

The trademark was incorrectly advertised in the Trademarks Journal dated December 18, 2019, Vol. 66 Issue 3399. The visual representation of the trademark should have been advertised in colour.